

Vehicle Emission Control Information

Vehicle Emission Control Information

Vehicle Emission Control Information (VECI) Decal

Each vehicle is equipped with a Vehicle Emission Control Information (VECI) Decal (Figure 1) containing emission control data that applies specifically to that vehicle and engine. The specifications provided on the decal are critical to servicing systems. The VECI decal is located under the hood next to the prop rod slot (Figure 2).

Figure 1: Typical Vehicle Emission Control Information (VECI) Decal

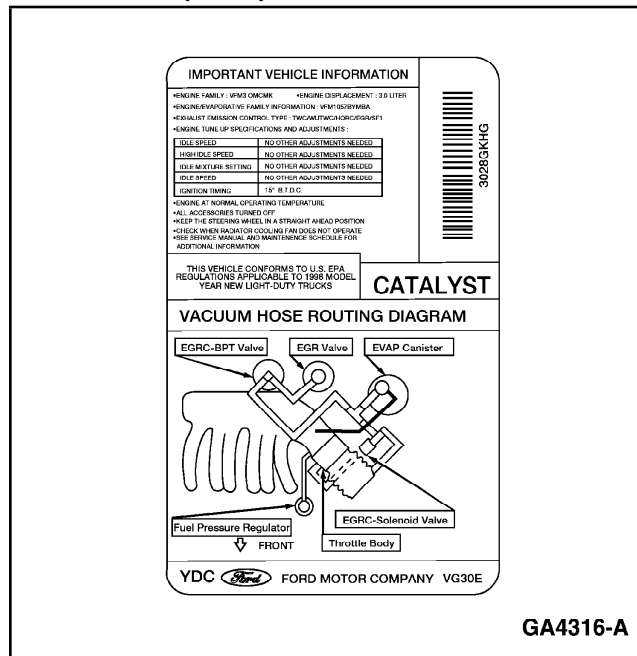

In addition to the tune-up specifications and procedures, the emission decal shows a schematic of the engine vacuum system.

Vehicle Emission Control Information

Figure 2: Vehicle Emission Control Information (VECI) Decal Location

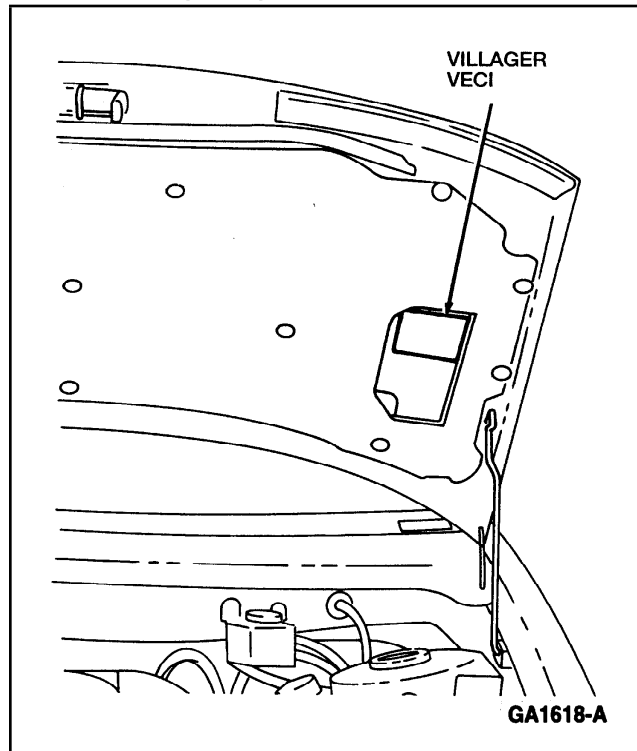

Emission Control System Information

Manufacturers must use a standardized system for identifying their individual engine families. The system described below was developed by the Environmental Protection Agency (EPA) in 1991 to meet new regulatory requirements for 1994 and later model years.

The ENGINE FAMILY name and EVAPORATIVE FAMILY name consists of 12 characters each.

Both the engine family name and the evaporative family names are listed in the box on the emission decal as indicated in Figure 3, in the area marked as engine/evaporative family information. The lines contain the engine size and the evaporative family name (12 characters).

Vehicle Emission Control Information

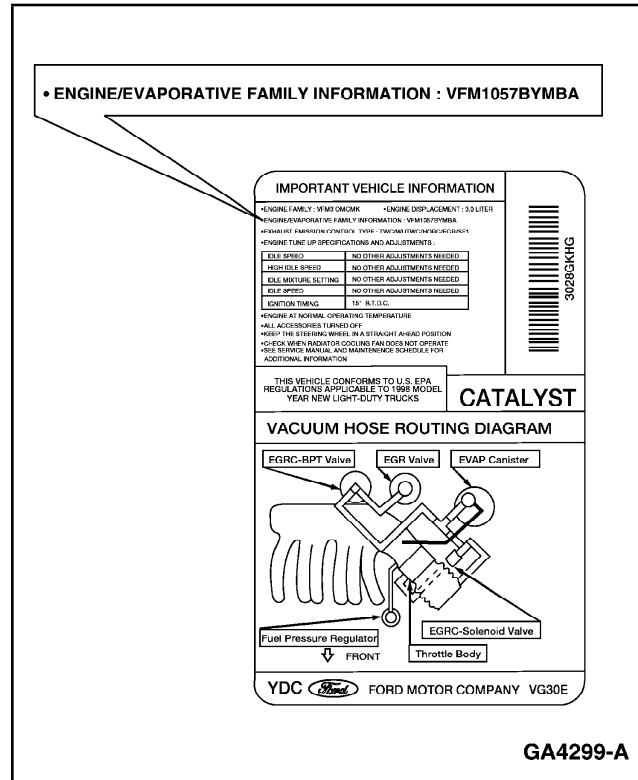

Figure 3: Typical California Decal Used As An Example. (Typical 49S Decal has the same type of information.)

EVAPORATIVE FAMILY NAMES (12 CHARACTERS)

Letter	Description
T	Model Year (See Table 1)
FM	Manufacturer (See Table 2)
1	Vapor Storage System (See Table 3)
120	Canister Work Capacity (See Table 4)
A	Canister Configuration and Purge Control (See Table 5)
Y	Fuel System (See Table 6)
M	Fuel Tank Material (See Table 7)
E	Standards (See Table 8)
B	Suffix (Any Letter)

Vehicle Emission Control Information

EPA STANDARD ENGINE FAMILY NAME (12 CHARACTERS)

Letter	Description
T	Model Year (See Table 1)
FM	Manufacturer (See Table 2)
3.0	Displacement in Letters-Decimal Point Counts as a Digit (See Table 10)
V	Vehicle Class (See Table 11)
J	Fuel Metering and Number of Valves Per Cylinder (See Table 12)
G	Combustion Cycle and Fuel Type (See Table 13)
1	Standards (See Table 14)
E	Catalyst/Trap (See Table 15)
K	OBD (See Table 9)

Table 1

SUBCODES FOR MODEL YEARS

Code	Model Year
S	1995
T	1996
V	1997
W	1998
X	1999

Table 2

SUBCODES FOR MANUFACTURERS

Subcode	Code	Manufacturer
FM	30	Ford Motor Company

Table 3

VAPOR STORAGE SYSTEM

Code	System Type
1	Canister
2	Crankcase
3	Air Cleaner
4	Canister & Crankcase
5	Crankcase & Air Cleaner
6	Canister & Air Cleaner
7	Canister & Crankcase & Air Cleaner

Table 4

Vehicle Emission Control Information

CANISTER WORK CAPACITY

Total Grams (All Canisters)

Table 5

CANISTER CONFIGURATION AND PURGE CONTROL

A	Plastic Housing	Closed Bottom	Purge controlled
B	Plastic Housing	Open Bottom	Purge controlled
C	Metal Housing	Closed Bottom	Purge controlled
D	Metal Housing	Open Bottom	Purge controlled
W	Plastic Housing	Closed Bottom	Purge not controlled
X	Plastic Housing	Open Bottom	Purge not controlled
Y	Metal Housing	Closed Bottom	Purge not controlled
Z	Metal Housing	Open Bottom	Purge not controlled

Table 6

FUEL SYSTEM

N	Carburetor (any type)
Y	Fuel Injection (any type)

Table 7

FUEL TANK MATERIAL

M	Metal
P	Plastic
C	Both metal and plastic tanks

Table 8

STANDARDS

0	Tier 0
1	Tier 1

Table 9

OBD STATUS

Codes ^a	Description
A to J (excluding I)	For Federal: OBD = No For California Only: California ARB OBD I or OBD not applicable for California ARB
K to T (excluding O)	For Federal: OBD = Yes

(Continued)

Vehicle Emission Control Information

OBD STATUS (Cont'd)

Codes ^a	Description
	For California Only: California ARB OBD II

a First code listed is preferred code, other codes may be used if necessary to separate engine families that would otherwise be named the same.

Code	Special Compliance Options
U	NCP For Federal: OBD = No For California Only: California ARB OBD I or OBD not applicable for California ARB
V	NCP For Federal: OBD = Yes For California Only: California ARB OBD II
W	Averaging or Bank/Trade For Federal: OBD = No For California Only: California ARB OBD I or OBD not applicable for California ARB
X	Averaging or Bank/Trade For Federal: OBD = Yes For California Only: California ARB OBD II

Table 10—Engine Displacement Characters 4, 5 and 6

Displacement in liters (e.g., 5.7 -- the decimal point counts as a digit) or cubic inches (e.g., 350). For dual displacement families, enter the larger displacement. For large displacement engines, the displacement may be entered as XX. format (e.g., 12.). Small motorcycle engines may be entered in a.XX format (e.g.,.07). In all cases the displacement will be read in liters if a decimal point is entered, and it will be read in cubic inches if there is no decimal point.

Table 11—Vehicle Class

LIGHT DUTY

Code	Description			Tier 1	Tier 0
	LVW	ALVW	GVWR		
V	LDV or California ARB's PC, any Tier, any Fuel				
			LDV	LDV	
Codes for LDTs in Tier 1					
1	All Fuels: <3750	Any	<6000	LDT ₁	N/A
2	All Fuels: >3750	Any	<6000	LDT ₂	N/A
3	Non-diesel: Any Diesel: <3750	3751-5750	>6000	LDT ₃ LDDT ₃	N/A
4	Non-diesel: Any Diesel: <3750	<5750	>6000	LDT ₄ LDDT ₄	N/A

(Continued)

Vehicle Emission Control Information

LIGHT DUTY (Cont'd)

Code	Description			Tier 1	Tier 0
	LVW	ALVW	GVWR		
Diesel Tier 1 LDTs Only					
5	Diesel: >3750	3751-5750	>6000	LDDT ₃	N/A
6	Diesel: >3750	>5750	>6000	LDDT ₄	N/A
Codes for LDTs in Tier 0—All Fuels					
7	<3750	Any	Any	—	LDT-A NO _x =1.2
8	>3750	Any	Any	—	LDT-B NO _x =1.7

CALIFORNIA ARB's MEDIUM DUTY (ONLY USE FOR CALIFORNIA-ONLY VEHICLES)

Code	Designation	GVWR	ALVW
G	MDT-1	<6000	0.3750
H	MDT-2	<6000	3751-5750
J	MDT-3	<6000	5751-8500
K	MDT-4	<6000	8501-10,000
L	MDT-5	<6000	10,001-14,000

HEAVY DUTY

Code	Useful Life	Standard	Description
A	LHDE	Light Duty	OPTION for <10,000 GVWR
B	LHDE	>14K GVWR	Typically GVWR <19.5K, HP 70-170
C	LHDE	>14K GVWR ^a	Typically GVWR <19.5K, HP 70-170
D	MHDE	>14K GVWR	Typically GVWR 19.5K-33K, HP 170-250
E	HHDE	>14K GVWR	Typically GVWR >33K HP > 250
F	HHDE	Urban Bus	HHDE Bus

a Also use this code for families containing both <14K and >14K GVWR

Table 12

FUEL METERING AND NUMBER OF VALVES PER CYLINDER

Code	Fuel System	Valves per Cylinder
0	Mult. Carb	2 Valves/Cylinder
1	1 BBL	2 Valves/Cylinder
2	2 BBL	2 Valves/Cylinder
3	3 BBL	2 Valves/Cylinder
4	4 BBL	2 Valves/Cylinder

(Continued)

Vehicle Emission Control Information

FUEL METERING AND NUMBER OF VALVES PER CYLINDER (Cont'd)

Code	Fuel System	Valves per Cylinder
5	Throttle Body Injection (TBI)	2 Valves/Cylinder
6	Mechanical MFI	2 Valves/Cylinder
7	Electrical MFI-simultaneous	2 Valves/Cylinder
8	Electrical MFI-sequential	2 Valves/Cylinder
9	Central Port Injection	2 Valves/Cylinder
A	Mult. Carb	3 or more Valves/Cylinder
B	1 BBL	3 or more Valves/Cylinder
C	2 BBL	3 or more Valves/Cylinder
D	3 BBL	3 or more Valves/Cylinder
E	4 BBL	3 or more Valves/Cylinder
F	Throttle Body Injection (TBI)	3 or more Valves/Cylinder
G	Mechanical MFI	3 or more Valves/Cylinder
H	Electrical MFI-simultaneous	3 or more Valves/Cylinder
J	Electrical MFI-sequential	3 or more Valves/Cylinder
K	Central Port Injection	3 or more Valves/Cylinder
Y	None (Electric)	
Z	Other	

Table 13

COMBUSTION CYCLE AND FUEL TYPE

Code	Cycle	Fuel	
G	Otto Cycle (SI)	Gasoline	Piston
M	Otto Cycle (SI)	Methanol	Piston
E	Otto Cycle (SI)	Ethanol	Piston
F	Otto Cycle (SI)	Flexible Fuel—Methanol-Gasoline	Piston
N	Otto Cycle (SI)	Other Flexible Fuel	Piston
C	Otto Cycle (SI)	CNG	Piston
L	Otto Cycle (SI)	LPG	Piston
R	Otto Cycle (SI)	Gasoline	Rotary
X	Otto Cycle (SI)	Other Fuels	Rotary
D	Diesel Cycle (CI)	Diesel Fuel	

(Continued)

Vehicle Emission Control Information

COMBUSTION CYCLE AND FUEL TYPE (Cont'd)

Code	Cycle	Fuel	
A	Diesel Cycle (CI)	Methanol	
B	Diesel Cycle (CI)	Ethanol	
H	Diesel Cycle (CI)	Flexible Fuel Methanol-Diesel	
J	Diesel Cycle (CI)	Other Flexible Fuel	
K	Diesel Cycle (CI)	CNG	
P	Diesel Cycle (CI)	LPG	
2	Two Stroke Cycle	Gasoline	
3	Two Stroke Cycle	Methanol/Ethanol	
4	Two Stroke Cycle	Diesel	
5	Two Stroke Cycle	CNG	
6	Two Stroke Cycle	LPG	
7	Two Stroke Cycle	Flexible Fuel	
T	Turbine	Gasoline	
Q	Turbine	Diesel	
S	Turbine	Methanol/Ethanol	
U	Turbine	CNG	
V	Turbine	LPG	
W	Turbine	Flexible Fuel	
Y	Hybrid Electric	—	
Z	Electric	—	

Table 14

STANDARDS

49-State and 50-State Families			
Code	Sales Class	HC, CO & NOx	PM
A	49 or 50 States	Tier 0	Any
B	49 or 50 States	Tier 0	Any
C	49 or 50 States	Tier 1	Tier 0
D	49 or 50 States	Tier 1	Tier 0
E	49 or 50 States	Tier 1	Tier 1
F	49 or 50 States	Tier 1	Tier 1
G	49 or 50 States	Tier 1	Tier 0
H	49 or 50 States	Tier 1	Tier 0
J	49 or 50 States	Tier 1	Tier 1
K	49 or 50 States	Tier 1	Tier 1
L-Z	(Reserved)		
California Only Families			
0	California ARB Tier 0	—	—
1	California ARB Tier 1	—	—

(Continued)

Vehicle Emission Control Information

STANDARDS (Cont'd)

49-State and 50-State Families			
Code	Sales Class	HC, CO & NOx	PM
2	California ARB TLEV	—	—
3	California ARB LEV	—	—
4	California ARB ULEV	—	—
5	California ARB ZEV (Electric)	—	—

Table 15

CATALYST/TRAP

Codes ^a	Description
Catalyst Type	
A, B	Ox Cat Only
C, D	Reduction Cat
E, F, G, H	3-Way Cat
J, K, L, M	3-Way + Ox Cat
N, P, Q	Heated Cat
R, S, T	No Cat
Trap Type	
1, 2	Trap-Active Regeneration
3, 4	Trap-Continuous Regeneration
5, 6	Trap-Continuous Regeneration + Fuel Add.
Description	
Y, Z	Other

a First code listed is preferred code, other codes may be used if necessary to separate engine families that would otherwise be named the same.

Acronym Definitions

ALVW—Adjusted Loaded Vehicle Weight, (Curb Weight + GVWR) /2.

CALIFORNIA ARB—California Air Pressure Board

CARB—California Air Resource Board.

CARB LEV—Low Emission Vehicle.

CARB TLEV—Transitional Low Emission Vehicle.

CARB ULEV—Ultra Low Emission Vehicle.

CARB ZEV—Zero Emission Vehicle.

CI—Cylinder Injection.

GVWR—Gross Vehicle Weight Rating, Curb weight plus payload.

Vehicle Emission Control Information

HHDE—Heavy Heavy Duty Diesel Engine.

MHDE—Medium Heavy Duty Diesel Engine.

LDDT—Light Duty Diesel Truck categories.

LDT—Light Duty Truck (gasoline) categories based on weight as defined in the table.

LDV—Light Duty Vehicle, generally passenger cars and light trucks under 6000 pounds GVWR.

LHDE—Light Heavy Duty Engine (several weight categories).

LVW—Loaded Vehicle Weight, curb weight plus 300 pounds.

MDT—Medium Duty Truck categories based on weight as defined in the table.

MHDE—Medium Heavy Duty Engine.

PC—Passenger Car.

SI—Sequential Injection.

Tier 0—California and Federal regulations effective prior to Tier 1 phase in dates.

Tier 1—California regulations beginning in 1993 model year and Federal regulations beginning in 1994 model year.

Abbreviations:

CONV - Conventional Systems

EGR - Exhaust Gas Recirculation

EGR BPT - Exhaust Gas Recirculation Back Pressure Transducer

EVAP - Evaporative Emission

EVAP - Evaporative Emissions Canister

IAC2 - Idle Air Control Valve 2

IAC1 - Idle Air Control Valve 1 (Formerly Fast Idle Control)

PCV - Positive Crankcase Ventilation

TI - Transistorized Ignition

WU- TWC - Warm Up Three Way Catalytic Converter

TWC - Three Way Catalytic Converter

UB - Underbody

VCC - Vacuum Cut Control Solenoid

Engine/Vehicle Applications and VIN Location

Application Chart

APPLICATION CHART

System	Application
Engine	3.0L
Cylinders	6
Injection	SFI
Valves per Cylinder Intake/Exhaust	1/1
Camshaft, Belt Drive	OHC
Free Wheeling	Yes

Vehicle Identification Number

The official Vehicle Identification Number (VIN) for title and registration purposes is stamped on a metal plate. The plate is fastened to the instrument panel near the windshield on the driver side of the vehicle (Figure 4) and is visible from the outside. The VIN is 17 characters long.

The last six digits of the VIN indicate the serial number of each unit built at each assembly plant. The production serial number begins with 100,000 and may sequence through 999,999.

Figure 4: VIN Location

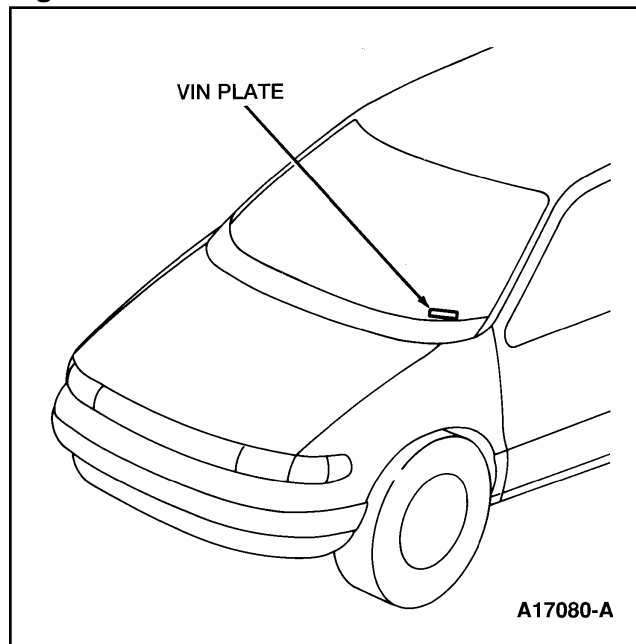

On Board Diagnostics II System

On Board Diagnostics II System

Overview

The California Air Resources Board (CARB) began regulation of On Board Diagnostics (OBD) for vehicles sold in California beginning with the 1988 model year. The first phase, OBDI, required monitoring of the fuel metering system, exhaust gas recirculation (EGR) system, and additional emission related components. The malfunction indicator lamp (MIL) was required to light and alert the driver of the malfunction and the need for service of the emission control system. The MIL must be labeled "CHECK ENGINE" or "SERVICE ENGINE SOON." Associated with the MIL was a fault code or diagnostic trouble code (DTC) identifying the specific area of the fault.

The OBD system was proposed by the CARB to improve air quality by identifying vehicles exceeding emission standards. Passage of the federal Clean Air Act Amendments in 1990 has also prompted the Environmental Protection Agency (EPA) to develop on board diagnostic requirements. CARB OBD II regulations will be followed until 1999 when the federal regulations will be used.

The OBD II system meets government regulations by monitoring the emission control system. When a system or component exceeds emission thresholds or a component operates outside of tolerance, a DTC will be stored and the MIL will be illuminated.

Fault detection strategy and MIL operation are associated with trips and drive cycles. Each monitor has requirements for setting and clearing DTCs and for controlling the MIL. These processes, DTC and MIL operation, descriptions of the monitors and the definition of trip and drive cycles are discussed in detail within this section.

The diagnostic executive is the computer program in the powertrain control module (PCM) that coordinates the OBD II self-monitoring system. This program controls all the monitors and interactions, DTC and MIL operation, freeze frame data and scan tool interface.

Freeze frame data describes stored engine conditions, such as state of the engine, state of fuel control, spark, RPM, load, and warm-up status at the point the first malfunction is detected. Previously stored conditions will be replaced only if a fuel or misfire malfunction is detected. This data is accessible with the scan tool to assist in repairing the vehicle.

Powertrain Control Module

The center of the OBD II system is a microprocessor called the powertrain control module (PCM). The PCM has a single 88 Pin connector. The PCM receives input from sensors and other electronic components (switches, relays, etc.). Based on information received and programmed into its memory (keep alive memory [KAM], etc.), the PCM generates output signals to control various relays, solenoids and actuators.

Keep Alive Memory (KAM) - The powertrain control module (PCM) stores information in keep alive memory (KAM), a memory integrated circuit, about vehicle operating conditions, and then uses this information to compensate for component variability. KAM remains powered when the vehicle ignition key is OFF so that this information is not lost.

On Board Diagnostics II System

Fail Safe - This system of special circuitry provides minimal engine operation should the powertrain control module (PCM), mainly the Central Processing Unit or EEPROM, stop functioning correctly. All modes of Self-Test are not functional at this time. Electronic hardware is in control of the system while in fail safe operation.

Component Control	Fail Safe Condition	Operation
IAC1		Idle Air Held To Full Open.
INJ 1 INJ 2 INJ 3 INJ 4 INJ 5 INJ 6		Fuel injection volume fixed according to driving conditions. Fuel is injected simultaneously into all cylinders once per crankshaft revolution. Timing for the injection is based upon the camshaft position sensor signal.
EGR/EVAP*	OFF	EGR Valve and EVAP Canister Control Solenoid Closed.
Ignition Timing		Ignition Timing Fixed.
HFAN	ON	High Fan Control Relay Energized.
LFAN	OFF	Low Fan Control Relay Unenergized.
ACR	OFF	A/C Relay Unenergized.
MIL	ON	Malfunction Indicator Lamp On.
FP	ON	Fuel Pump Control Relay Energized (Engine Running).

* Federal emissions

Adaptive Fuel Control Strategy

The adaptive fuel control strategy is designed to compensate for variability in the fuel system components. If, during normal vehicle operation, the fuel system is detected to be biased rich or lean, the adaptive fuel control will make a corresponding shift in the fuel delivery calculation.

Whenever an injector or fuel pressure regulator is replaced, keep alive memory (KAM) should be cleared. This is necessary so the fuel strategy does not use the previously learned adaptive values.

To clear KAM, refer to PCM Reset in Section 2B, Diagnostic Methods.

Failure Mode Effects Management

Failure mode effects management (FMEM) is an alternate system strategy in the powertrain control module (PCM) designed to maintain vehicle operation if one or more sensor inputs fail.

When a sensor input is perceived to be out-of-limits by the PCM, an alternative strategy is initiated. The PCM substitutes a fixed value and continues to monitor the incorrect sensor input. If the suspect sensor operates within limits, the PCM returns to the normal engine running strategy.

On Board Diagnostics II System

Engine RPM/Vehicle Speed Limiter

The powertrain control module (PCM) will disable all of the fuel injectors whenever an engine RPM or vehicle overspeed condition is detected. The purpose of the engine RPM or vehicle speed limiter is to prevent damage to the powertrain. In this strategy, the vehicle will exhibit a rough running engine condition. Once the driver reduces the excessive speed, the vehicle will return to the normal operating strategy.

Common OBD II Terms

Trip: A trip is defined as a Key-ON, Key-OFF event in which the powertrain control module (PCM) detects the following:

1. Engine coolant temperature should exceed 70°C degrees (158°F).
2. Engine coolant temperature should change more than 20°C degrees (68°F) after starting the engine.
3. Engine speed should go over 400 RPM.

TWO TRIP DETECTION LOGIC

When the powertrain control module (PCM) detects a malfunction during the 1st trip, the DTC and corresponding freeze frame data are stored in the PCM's memory. The malfunction indicator lamp (MIL) will not be illuminated until the fault is detected again during the 2nd trip. Certain DTCs are capable of turning the MIL light on or blinking it during the first trip.

Diagnostic Trouble Code (DTC)

DTCs used in OBD II vehicles will begin with a letter and are followed by four numbers. The letter at the beginning of the DTC identifies the function of the monitored device that has failed. A P indicates a powertrain device, C indicates a chassis device, B is for body device and U indicates a network or data link code.

The first number indicates if the code is generic (common to all manufacturers), or if it is manufacturer specific. A 0 indicates generic, 1 indicates manufacturer-specific.

The second number indicates the system that is affected with a number between 1-7. The following is a list showing what numbers are assigned to each system.

1. Fuel and air metering
2. Fuel and air metering (injector circuit malfunctions only)
3. Ignition system or misfire
4. Auxiliary emission controls

On Board Diagnostics II System

5. Vehicle speed controls and idle control system
6. Computer output circuits
7. Transmission

The last two numbers of the DTC indicate the component or section of the system where the fault is located.

Malfunction Indicator Light (MIL)

When the PCM detects an emission related DTC during the 1st trip, the DTC and engine data are stored in the freeze frame memory. The MIL light is illuminated only when the PCM detects the same emission related DTC after it occurs in two consecutive trips. Once the MIL is illuminated, it will only turn off after the PCM detects three trips without any malfunctions occurring. DTCs that would cause vehicle emissions to exceed the federal limit are capable of illuminating or blinking the MIL during the 1st trip.

Diagnostic Trouble Codes Capable of Illuminating the MIL When Detected on the 1st Trip

Misfire diagnostic trouble codes

Catalyst diagnostic trouble codes

Closed loop control diagnostic trouble codes

Fuel Trim

For OBD II vehicles, long term and short term fuel trim values will be shown in percentages. Freeze frame will also show fuel trim values as percentages. Fuel trim represents how much compensation the powertrain control module (PCM) must make from ideal conditions. A higher positive value for fuel trim indicates the PCM is commanding more fuel into the engine, this can be caused by vacuum leaks, restricted fuel injectors, etc. A highly negative value indicates a lean engine command, possibly caused by leaky injectors, etc.

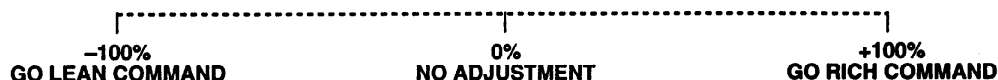

GA1620-A

On Board Diagnostics II System

FREEZE FRAME DATA

When a freeze frame event is triggered by an emissions related diagnostic trouble code (DTC), the powertrain control module (PCM) stores various vehicle information as it existed the moment the malfunction occurred. The DTC number along with the engine data can be useful in aiding a technician in locating the cause of the malfunction. Once the data from the 1st trip DTC occurrence is stored in the freeze frame memory, it will remain there even when the fault occurs again (2nd trip) and the MIL is illuminated. Freeze frame data will not be displayed after 40 drive cycles have occurred without a fault. Data can be stored in freeze frame for only one event, however, the PCM will prioritize what data it will store. For example, an EGR malfunction (priority 2) was detected during the 1st trip and the freeze frame data stored. After that, a misfire DTC occurs (priority 1) in another trip; the misfire data will replace the EGR data stored in the freeze frame memory, except after a misfire or fuel injection system DTC, which will not be cleared until 80 consecutive drive cycles have occurred without a fault.

OBD II System Readiness Tests (SRT)

The OBD II system readiness tests (SRT) are:

- Exhaust gas recirculation (EGR) system monitor
- Heated oxygen sensor (HO2S) monitor
- Catalyst efficiency monitor
- Misfire detection monitor
- Fuel system monitor
- Comprehensive component monitor
- Evaporative emission system monitor

Exhaust Gas Recirculation System Monitor

The exhaust gas recirculation (EGR) system monitor is a self-test strategy within the powertrain control module (PCM) that tests the integrity of the EGR system. The EGR monitor uses an EGR temperature sensor to detect a malfunction in any of the EGR system components and/or control circuitry.

Heated Oxygen Sensor Monitor

OBD II regulations require monitoring of the upstream heated oxygen sensor (HO2S) to detect if the deterioration of the sensor has exceeded emission thresholds. An additional HO2S is located downstream of the warm up- three way catalytic converter (WU-TWC) to determine the efficiency of the catalyst. Although the downstream HO2S is similar to the type used for fuel control, it functions differently. The downstream HO2S is monitored to determine if a voltage is generated. That voltage is compared to a calibrated acceptable range.

On Board Diagnostics II System

Catalyst Efficiency Monitor

The catalyst efficiency monitor is a self-test strategy within the powertrain control module (PCM) that uses the downstream heated oxygen sensor (HO2S) to determine when a catalyst has fallen below the minimum level of effectiveness in its ability to control exhaust emissions.

Misfire Detection Monitor

Misfire is defined as the lack of proper combustion in the cylinder due to the absence of spark, poor fuel metering, or poor compression. Any combustion that does not occur within the cylinder(s) at the proper time is also a misfire. The misfire detection monitor detects fuel, ignition or mechanically induced misfires. The intent is to protect the catalyst from permanent damage and to alert the customer of an emission failure or an inspection maintenance failure by illuminating the malfunction indicator lamp (MIL). When a misfire is detected, special software called "freeze frame" data is enabled. The freeze frame data captures the operational state of the vehicle when a malfunction is detected from misfire detection monitor strategy.

Fuel System Monitor

The fuel system monitor is a self-test strategy within the powertrain control module (PCM) that monitors the adaptive fuel table. The fuel control system uses the adaptive fuel table to compensate for normal variability of the fuel system components caused by wear or aging. During normal vehicle operation, if the fuel system appears "biased" lean or rich, the adaptive fuel table will shift the fuel delivery calculations to remove the bias.

Comprehensive Component Monitor

The comprehensive component monitor is a self-test strategy within the powertrain control module (PCM) that detects malfunctions of any electronic powertrain component or system that provides input to the PCM and is not exclusively an input to any other OBD II monitor.

Evaporative Emission System Monitor

The evaporative emission (EVAP) system monitor is a self-test strategy within the powertrain control module (PCM) that tests the integrity of the EVAP system. When a malfunction occurs, the EVAP system monitor is reset to "NO" and a diagnostic trouble code (DTC) is set in the PCM memory. After the DTC is repaired the vehicle drive cycle must be driven to reset the monitor in preparation for Inspection Maintenance (I/M) testing.

Trips and Drive Cycles

Trip

A trip is defined as a Key-On, Key-Off event in which the powertrain control module (PCM) detects the following:

- (1) Engine coolant should exceed 70°C (158°F).
- (2) Engine coolant temperature should change more than 20°C (68°F) after starting the engine.
- (3) Engine speed should go over 400 RPM.

When the PCM detects an emission related diagnostic trouble code (DTC), it uses the trip information to make its decision on whether to illuminate the malfunction indicator lamp (MIL) light.

Trip Display on Scan Tool

The on-board system readiness function is available on all scan tools. This function indicates the status of each OBD II System Readiness Tests (SRT). One parameter identification display (PID) on a New Generation STAR (NGS) tester summarizes the status of all monitors.

Trips and Malfunction Indicator Lamp Function

Trips are used by the software strategy to control the malfunction indicator lamp (MIL) off function. The MIL is turned on after an emission related diagnostic trouble code (DTC) is stored in memory. The MIL is turned off if there are three consecutive drive cycles (refer to Drive Cycle in Section 2B) without the identical fault under similar conditions or three trips without the identical fault present. The actual number of drive cycles or trips necessary to control the MIL varies with each monitor. (Refer to specific monitor description and operation in this section.)

Trips and Diagnostic Trouble Codes

A diagnostic trouble code (DTC) will be stored in memory after the identical malfunction has been detected consecutively on at least two separate drive cycles (not necessarily completing a trip). A misfire detection monitor DTC can be stored immediately depending on the misfire type. A catalyst efficiency monitor DTC can be stored after three identical malfunctions are detected on three separate drive cycles. A DTC will be erased from memory after 40 engine warm-up cycles, except for misfire or fuel injection system DTCs which will be cleared after 80 warm-up cycles, if the malfunction has not been detected after the malfunction indicator lamp (MIL) is turned off. DTC memory storage requirements vary with each monitor. (Refer to the specific monitor in this section for more information.)

Drive Cycle

A drive cycle is a method of driving a vehicle to run all of the on-board diagnostics. It can also be a method of driving a vehicle to initiate and complete a specific OBD II System Readiness Test (SRT) or trip. A drive cycle may be done in the service bay or may require specific drive modes such as a number of idle periods, steady vehicle speed per time, accelerations at certain throttle angles, etc.

Trips and Drive Cycles

OBD II Drive Cycle

The OBD II Drive Cycle is a specific method used to perform all trip monitor tests, as well as the catalyst efficiency monitor test. (Refer to Drive Cycles in Section 2B.)

Inspection/Maintenance Testing — OBD II System Readiness Tests (SRT)

In some areas of the country, it may become a legal requirement to pass an Inspection/Maintenance (I/M) test of the On-Board Diagnostic Generation II (OBD II) system. Before I/M testing can proceed, the OBD II System Readiness Tests (SRT) must all indicate a “yes” condition; if not, the OBD II Drive Cycle must be performed. During the mix of city and highway driving involved in the OBD II drive cycle, the diagnostic monitors will test certain parts of the OBD II software and hardware used to control vehicle emissions. While some of the monitors will run to completion and indicate a Yes or No, others such as misfire or fuel system will continuously run.

The Villager OBD II System Readiness Tests (SRT) are listed below:

Misfire	Continuous
Fuel System Monitoring	Continuous
Comprehensive Component Monitoring	Continuous
Catalyst	No/Yes
Oxygen Sensor	No/Yes
Oxygen Sensor Heater	No/Yes
Exhaust Gas Recirculation (EGR) System	No/Yes
Evaporative Emission System	No/Yes

Malfunction Indicator Lamp (MIL)

The malfunction indicator lamp (MIL) (Figure 1) alerts the driver that the powertrain control module (PCM) has detected an OBD II emission related component or system malfunction. When this occurs, an OBD II diagnostic trouble code (DTC) will be set.

When a malfunction has been detected in two consecutive drive trips, a DTC will be stored in the PCM and the MIL will be turned on. The MIL will be turned off after three consecutive trips have been completed without the same malfunction being detected. The DTC will be erased from keep alive memory (KAM) after 40 warm-ups without the malfunction being detected, except for misfire or fuel injection system DTCs which will be erased after 80 warm-ups without a malfunction being detected. The only exception to this is if a misfire occurs that could cause damage to the catalyst. In that event, the MIL will be turned on immediately or may flash.

The MIL is located on the dashboard and is labeled "CHECK ENGINE." Power is supplied to the MIL whenever the ignition switch is in the run or crank position. The MIL will remain on in the run/crank mode as a bulb check until the camshaft position (CMP) signal is detected. The light may also be on due to a short to ground of the MIL circuit, or operation in the fail safe mode. In addition, the MIL will remain on if the MIL was on when the vehicle was last shut down. If the MIL does not turn off while the engine is cranking, it could indicate the PCM is not receiving the CMP signal or the MIL circuit is shorted to ground. If the MIL blinks, there is a severe misfire or an intermittent in the MIL circuit.

To extinguish the MIL after a repair, a reset command from the scan tool must be sent, or three consecutive drive cycles must be completed without a malfunction. (Refer to Trips and Drive Cycles in this section for more information.) If the MIL never comes on or the vehicle is a no-start, go to Section 3B, Symptom Charts.

Figure 1: Malfunction Indicator Lamp (MIL)

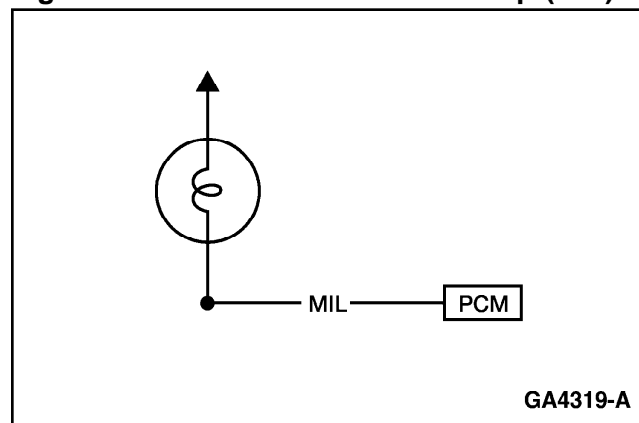

Ignition System

Ignition System

Ignition and Timing Systems

The ignition system provides spark control to the engine during all modes of operation. The ignition system consists of three subsystems: primary ignition, secondary ignition, and timing advance. The 3.0L engine uses a power transistor, resistor and condenser, and coil mounted separately from the distributor.

Primary Ignition Components

The primary ignition components include the coil primary circuit, the power transistor, and the ignition switch. When the ignition switch is turned on, it charges the primary coil windings. When the engine is running, the powertrain control module (PCM) sends a signal to the power transistor. The power transistor grounds the negative side of the coil primary circuit, generating the proper voltage in the secondary circuit which induces spark.

Secondary Ignition Components

The secondary ignition components include the spark plugs, the spark plug wires, the distributor cap, the rotor, and the coil secondary circuit. When the power transistor grounds the primary circuit, the inductive charge built up in the secondary circuit sends a spark from the coil to the distributor. The rotor and distributor cap then send a spark to each spark plug.

Timing Advance Components

The spark advance and retard functions are controlled by the powertrain control module (PCM). The PCM receives signals from various switches and sensors and then sends the spark timing signal through the power transistor and the ignition coil to the distributor.

Camshaft Position (CMP) Sensor

The camshaft position (CMP) sensor (Figure 1) is mounted inside the distributor housing. The CMP sensor has a rotor plate and a wave-forming circuit. The rotor plate has 360 slits for 1 degree signals and 6 slits for 120 degree signals. When the rotor plate passes between the light emitting diodes (LEDs) and the photo diode built into the wave-forming circuit, an input signal is generated and sent to the powertrain control module (PCM). This signal notifies the PCM of the engine speed at 1 degree intervals and the crankshaft position at 120 degree intervals.

Ignition System

Figure 1: Camshaft Position (CMP) Sensor

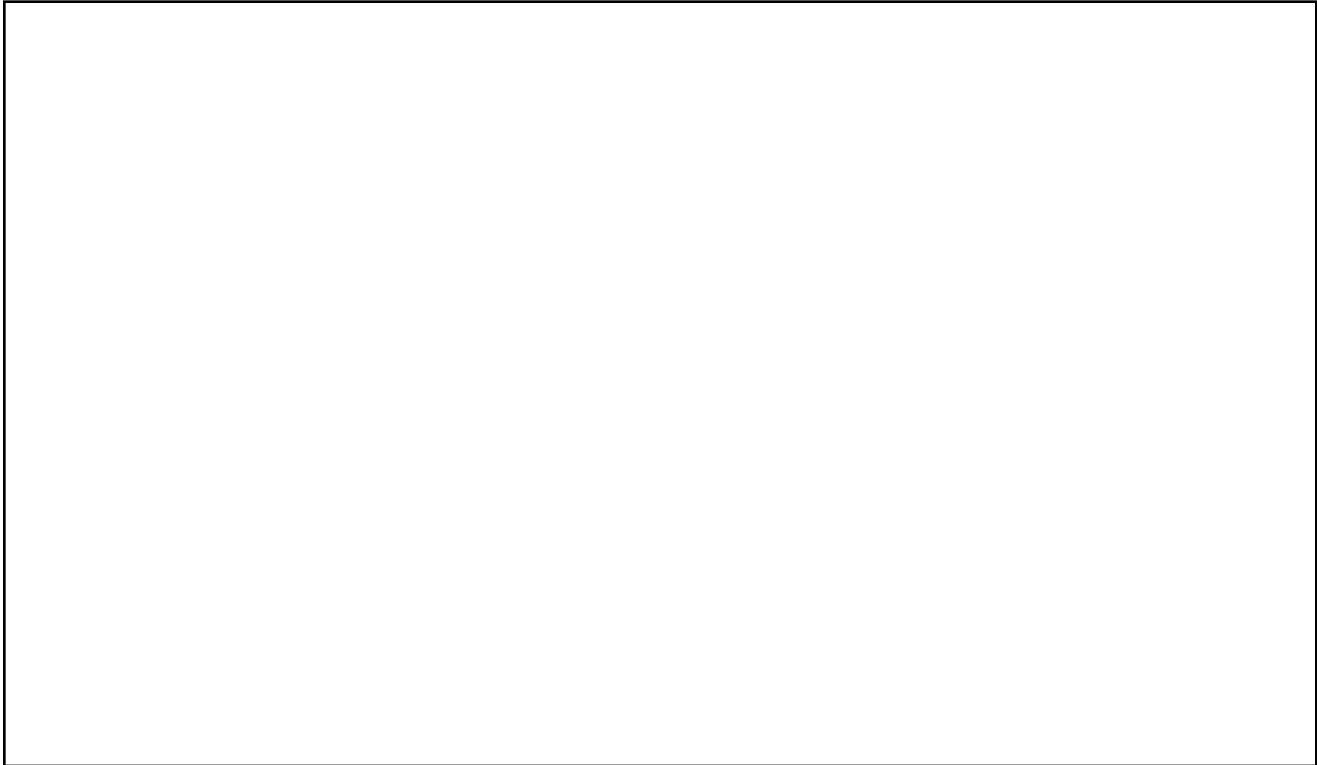

Knock Sensor (KS)

The knock sensor (KS) (Figure 2) detects engine knocking conditions and sends a signal to the powertrain control module (PCM). A knocking vibration from the engine block is applied as a pressure to the piezoelectric element of the KS. This vibrational pressure is then converted into a voltage signal which is delivered to the PCM. The PCM then retards the ignition timing to compensate for the condition. The KS is attached to the engine block between the cylinder banks. The MIL will not be illuminated for a KS malfunction.

Figure 2: Knock Sensor (KS)



Ignition System

Power Transistor

The ignition timing is controlled by the powertrain control module (PCM). The PCM detects information such as the injection pulse width and camshaft position sensor (CMP) signal which varies every moment. Then, responding to this information, an ignition signal is sent to the power transistor (Figure 3). The power transistor amplifies this signal and turns the ignition coil primary circuit on and off, inducing a high voltage in the secondary circuit. The ignition coil is a small, molded type.

Figure 3: Power Transistor

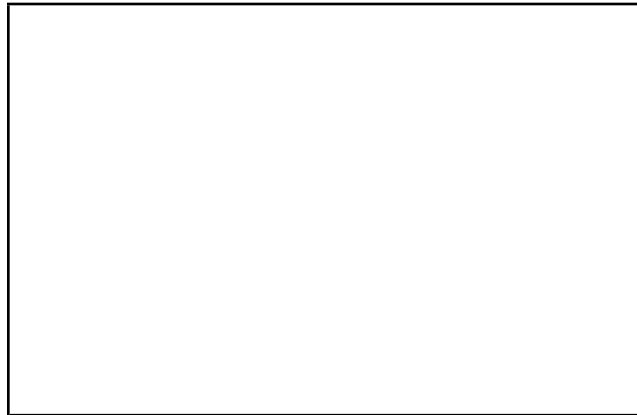

Fuel System

Fuel System

Fuel System

The fuel system consists of a fuel tank with reservoir, fuel pump assembly, fuel supply and return lines, fuel filters, fuel rail, fuel injector, and fuel pressure regulator (Figure 1).

When the ignition switch is in the ON or START position, power is supplied to the fuel pump relay and to the powertrain control module (PCM). The fuel pump is commanded on by the PCM grounding the coil in the fuel pump relay. The fuel pump is turned on via the inertia fuel shutoff switch whenever the ignition switch is in the ON or START position. If the PCM detects that the engine has not started or has stopped, it will turn off the fuel pump after 1.5 seconds. This is done to reduce the risk of draining the battery and damaging the fuel pump. The inertia fuel shutoff switch is a safety device which interrupts fuel pump power in the event of a collision. If the inertia fuel shutoff switch is "tripped," it must be reset by depressing the button on top of the switch. The switch is located on the LH side of the kick panel, below the hood release handle.

Figure 1: Fuel System Schematic

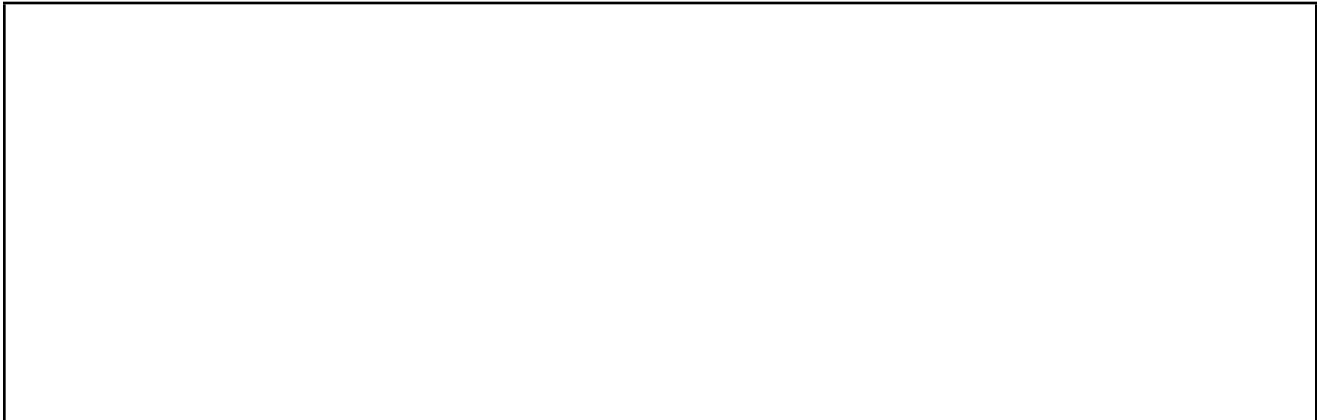

Item	Part Number	Description
1	—	Fuel Line Return
2	—	Fuel Tank
3	—	Inlet Fuel Filter
4	—	Fuel Pump
5	—	Pressure Fuel Line
6	—	In-Line Fuel Filter
7	—	Fuel Injectors
8	—	Fuel Pressure Regulator

Fuel Filter

The fuel filter (Figure 2) strains particles from the fuel through a paper element. This filtration process reduces the possibility of an obstruction in any of the fuel injector orifices. This vehicle uses a specially designed fuel filter that has a metal case in order to withstand high fuel pressure.

Fuel System

Figure 2: Fuel Filter

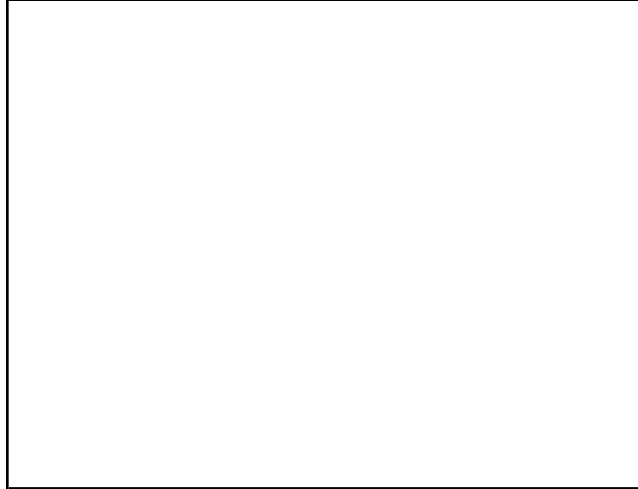

Fuel Injector (INJ)

The fuel injectors (Figure 3) are electronically controlled solenoid valves that control fuel flow to the engine. The injectors are controlled by the powertrain control module (PCM), the fuel pressure regulator, and the intake manifold vacuum. When the PCM sends a signal to the injector, the coil in the injector pulls a ball back and fuel is released into the intake manifold through the nozzle. The injected fuel is controlled by the PCM in terms of injection pulse duration. These injectors are side feed type injectors.

Figure 3: Fuel Injector

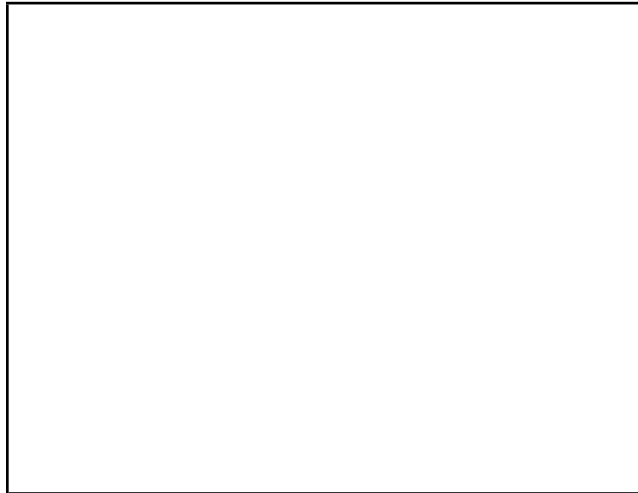

Fuel System

Fuel Pressure Regulator

The fuel pressure regulator (Figure 4) maintains the fuel pressure at 294 kPa (43 psi). Since the injected fuel amount depends on injection pulse duration, it is necessary to maintain the pressure at the above value. The fuel pressure decreases as the vacuum increases. At idle when vacuum is applied, the fuel pressure is 235 kPa (34 psi). When no vacuum is applied, the fuel pressure is 294 kPa (43 psi).

Figure 4: Fuel Pressure Regulator

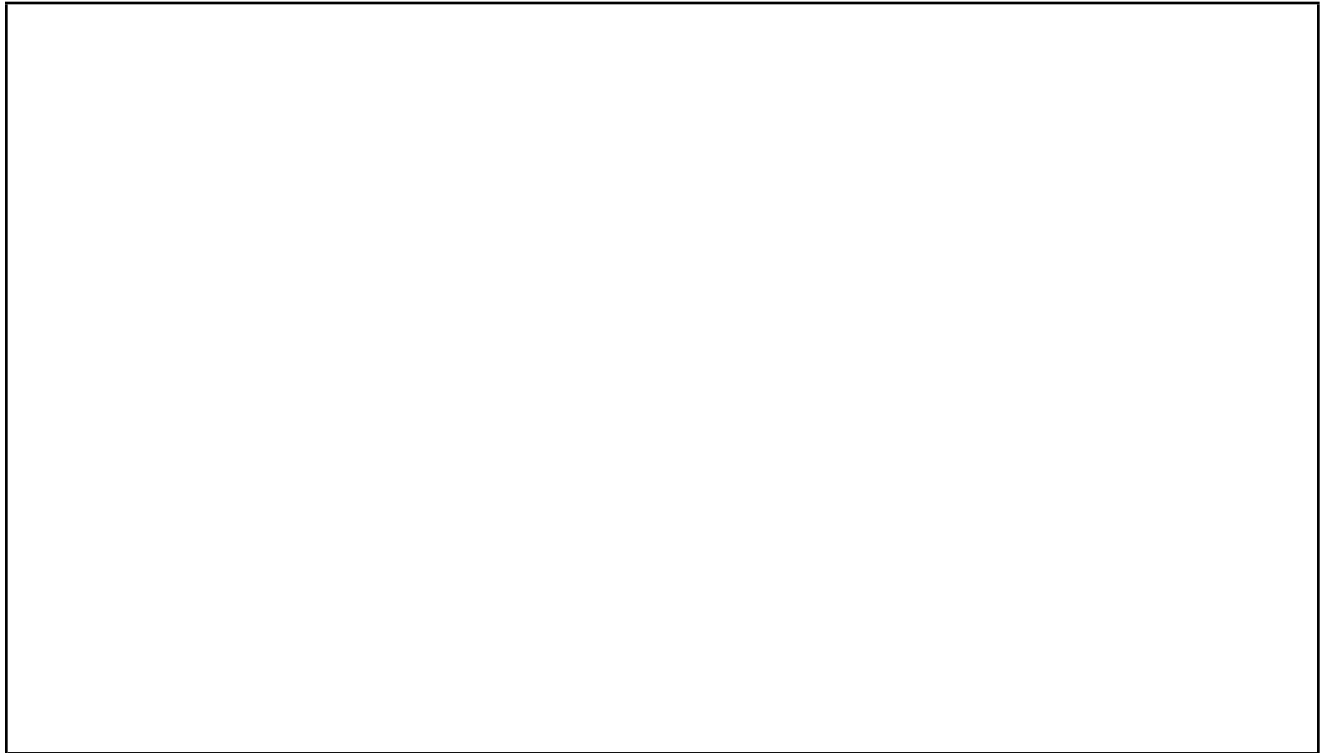

Fuel Pump (FP)

The fuel pump (FP) filters solid particles from the fuel and allows the fuel to be transmitted from the fuel tank to the engine. The FP with a fuel damper is an in-tank type. This means the pump and the damper are located in the fuel tank. The FP (Figure 5) has an internal motor which creates pressure in the fuel lines. The FP is controlled by a fuel pump relay, which is controlled by the powertrain control module (PCM).

Fuel System

Figure 5: Fuel Pump

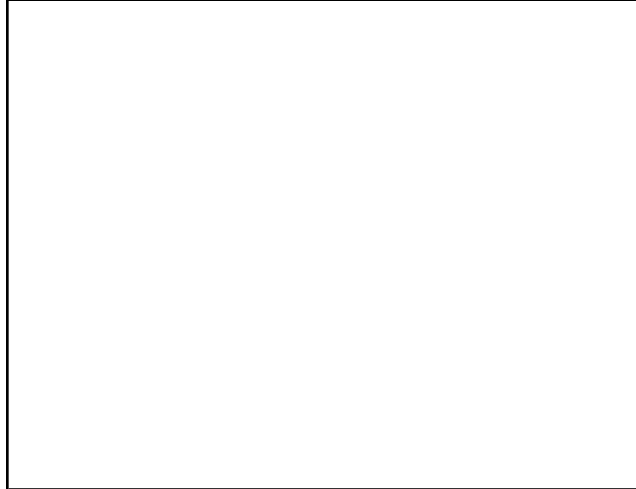

Fuel Temperature Sensor (California Emissions Only)

The fuel temperature sensor (Figure 6) is located in the fuel tank, clipped onto the fuel pump module. This sensor is an input into the powertrain control module (PCM). Its data is used primarily by the PCM in calculating the operation of the evaporative (EVAP) emission system.

Figure 6: Fuel Temperature Sensor



Fuel Pump Relay

The fuel pump (FP) relay (Figure 7) supplies voltage to the FP when activated by the powertrain control module (PCM). The PCM activates the FP relay for five seconds after turning the ignition key ON, and when the engine is cranking or running. The PCM deactivates the FP relay 1.5 seconds after the engine stops. The voltage supplied from the FP relay allows the FP motor to operate. When the PCM receives a 120 degree signal from the camshaft position (CMP) sensor, it knows that the engine is rotating, and causes the FP relay to activate. When activated, the FP relay supplies the FP with voltage, which allows it to operate continuously as long as the engine is running. If the PCM does not receive a 120 degree signal when the ignition switch is ON, the engine is stalled. The FP relay is deactivated and prevents battery discharging, thereby improving safety.

Fuel System

Figure 7: Fuel Pump Relay

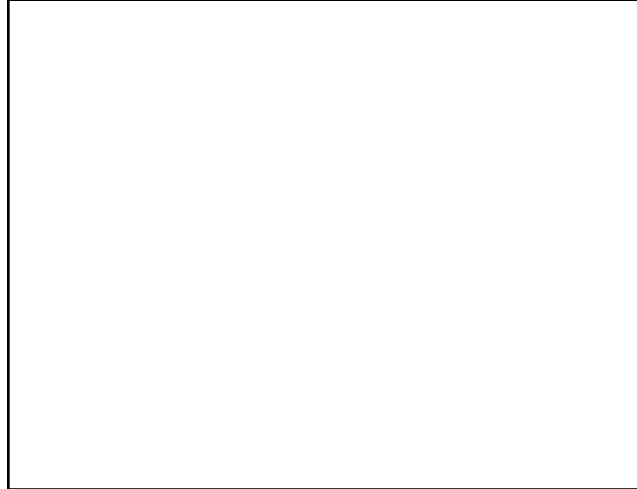

Inertia Fuel Shutoff (IFS) Switch

The inertia fuel shutoff (IFS) switch (Figure 8) is used in conjunction with the electric fuel pump. The purpose of the IFS is to shut off the fuel pump if a collision occurs. It consists of a steel ball held in place by a magnet. When a sharp impact occurs, the ball breaks loose from the magnet, rolls up a conical ramp and strikes a target plate which opens the electrical contacts of the switch and shuts off the electric fuel pump. Once the switch is open, it must be manually reset before restarting the vehicle. The IFS location can be seen in Figure 9.

Fuel System

Figure 8: Typical Inertia Fuel Shutoff (IFS) Switch

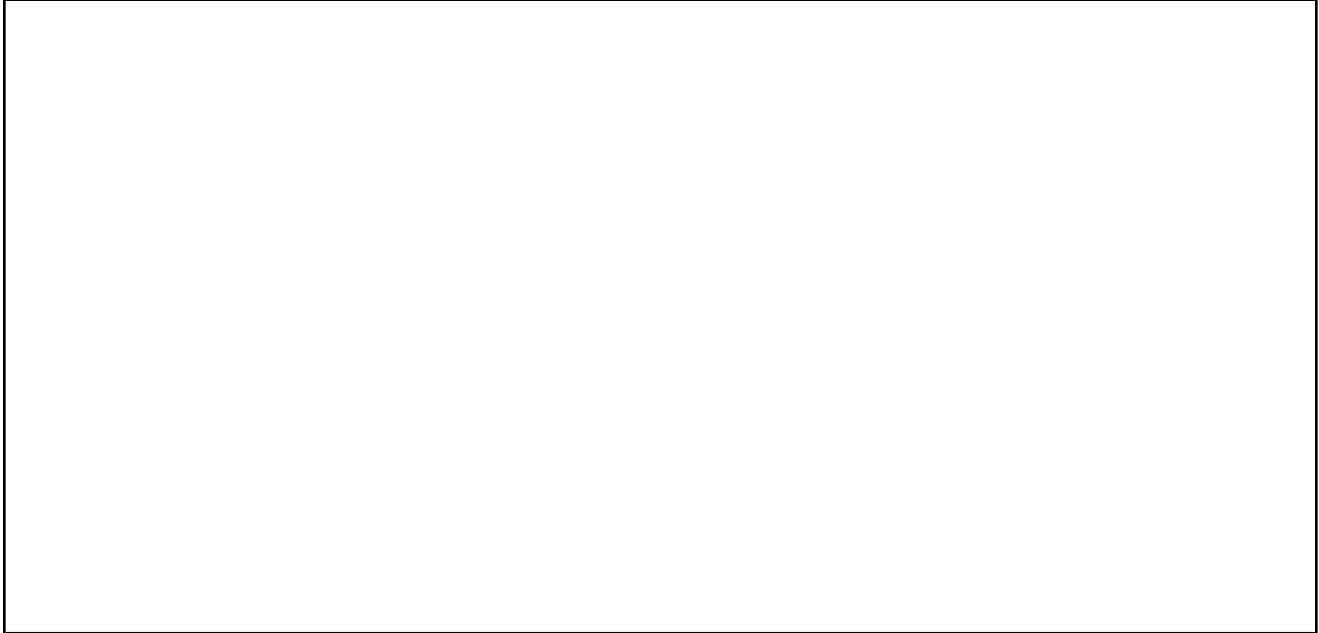

Item	Part Number	Description
1	—	Ball
2	—	Target Plate
3	—	Reset Button Position for Open Switch
4	—	Reset Button Position for Closed Switch
5	—	Magnet
6	—	Switch Terminals
7	—	Electrical Contacts

Figure 9: Inertial Fuel Shutoff Location



Exhaust Gas Recirculation System

Exhaust Gas Recirculation System

Exhaust Gas Recirculation (EGR) System Operation

The exhaust gas recirculation (EGR) system (Figures 1 and 2) recirculates a portion of the exhaust gases into the intake manifold under average vehicle driving conditions to reduce combustion temperatures and exhaust gas NO_x content. The amount of exhaust gas recirculated varies according to operating conditions and will be cut completely under:

- Engine starting condition
- Low engine coolant temperature condition
- Excessively high engine coolant temperature condition
- Engine idling condition
- High engine speed condition
- Mass air flow sensor failure

The exhaust gas recirculation (EGR) system on the Villager uses the exhaust gas recirculation/evaporative emission (EGR/EVAP) control solenoid valve to provide vacuum to both the EGR valve and the EVAP canister when commanded by the PCM. If the exhaust backpressure is sufficient to close the EGR backpressure transducer valve, vacuum is sent to the EGR valve and allows EGR gas to flow into the intake manifold. If the exhaust backpressure is not sufficient, the EGR backpressure transducer will remain open and allow vacuum from the EGR/EVAP control solenoid to vent to the atmosphere. Vehicles equipped with California emissions have separate solenoids for the EGR and EVAP systems.

The EGR system monitor, for OBD II regulations, uses an EGR temperature sensor to monitor the EGR system. The EGR temperature sensor is a thermister located in the EGR passageway. When hot exhaust gas is recirculated into the engine, the temperature at the EGR passageway increases. This increase is sensed by the EGR temperature sensor and a signal is sent to the PCM to indicate EGR flow. If the EGR temperature sensor does not detect EGR flow when commanded by the PCM after two consecutive trips, the malfunction indicator lamp (MIL) will be illuminated and a diagnostic trouble code (DTC) will be stored. The MIL will be turned off after three consecutive trips are completed with no malfunctions detected. The DTC will remain stored in the PCM memory until 80 trips have been completed without the same malfunction detected in the system.

Exhaust Gas Recirculation System

Figure 1: Exhaust Gas Recirculation (EGR) System Diagram (Federal Emissions)



Item	Part Number	Description
1	—	EGR/EVAP Control Solenoid
2	—	Air Cleaner Housing
3	—	Throttle Valve
4	—	EGR Temperature Sensor
5	—	EGR Valve
6	—	EGR Backpressure Transducer
7	—	EVAP Canister

Exhaust Gas Recirculation System

Figure 2: Exhaust Gas Recirculation (EGR) System Diagram (California Emissions)

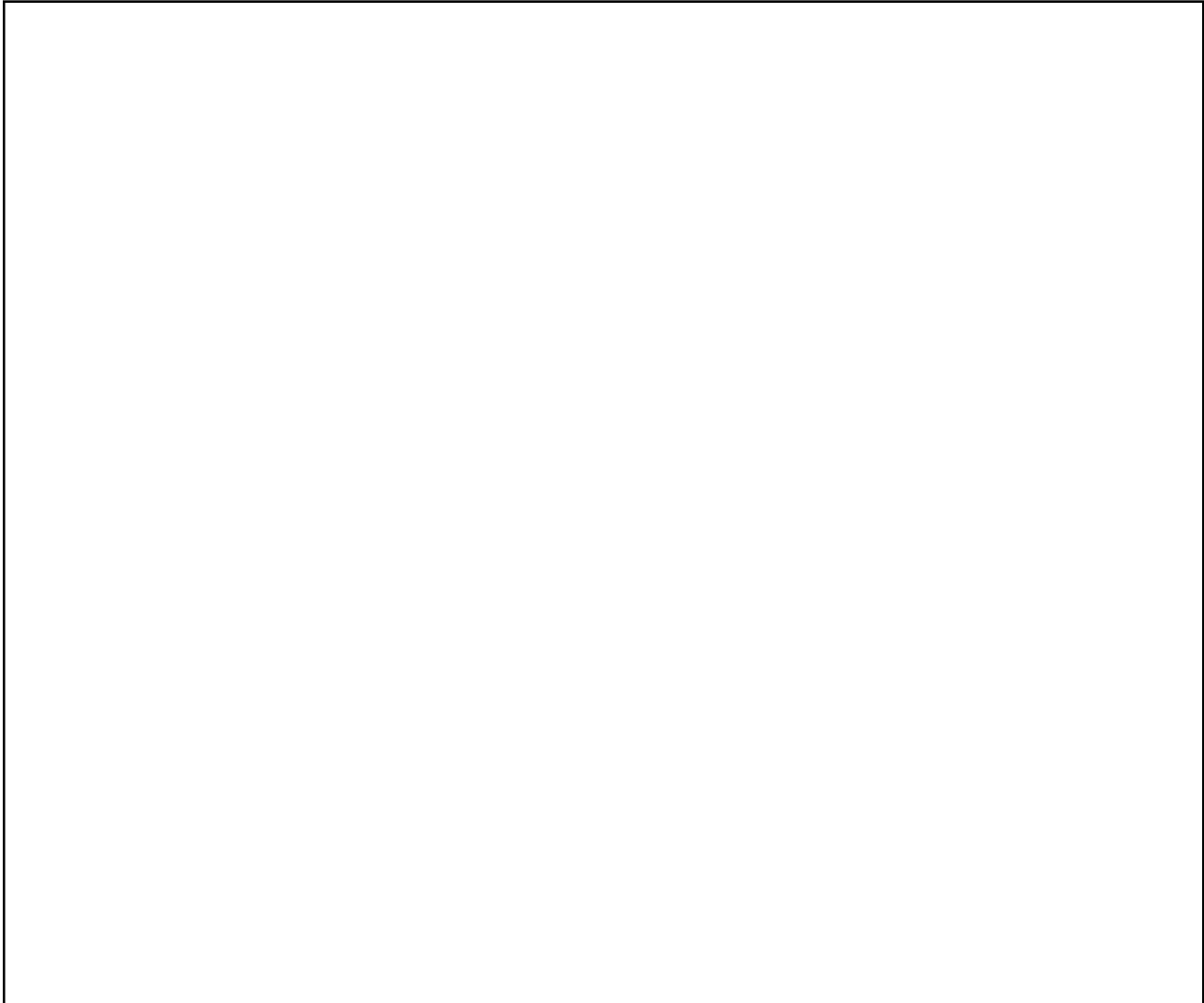

Item	Part Number	Description
1	—	EGR Control Solenoid
2	—	Air Cleaner Housing
3	—	Throttle Valve
4	—	EGR Temperature Sensor
5	—	EGR Valve
6	—	EGR Backpressure Transducer

Exhaust Gas Recirculation System

Exhaust Gas Recirculation (EGR) Backpressure Transducer Valve

The exhaust gas recirculation (EGR) backpressure transducer valve (Figure 3) is used to control EGR. The EGR valve is operated by ported vacuum, but the ported vacuum will normally be vented off at the EGR backpressure transducer valve. As engine RPM increases, exhaust pressure increases and pushes on the diaphragm in the EGR backpressure transducer valve and closes the vacuum vent.

Figure 3: EGR Backpressure Transducer Valve (Federal Emissions)

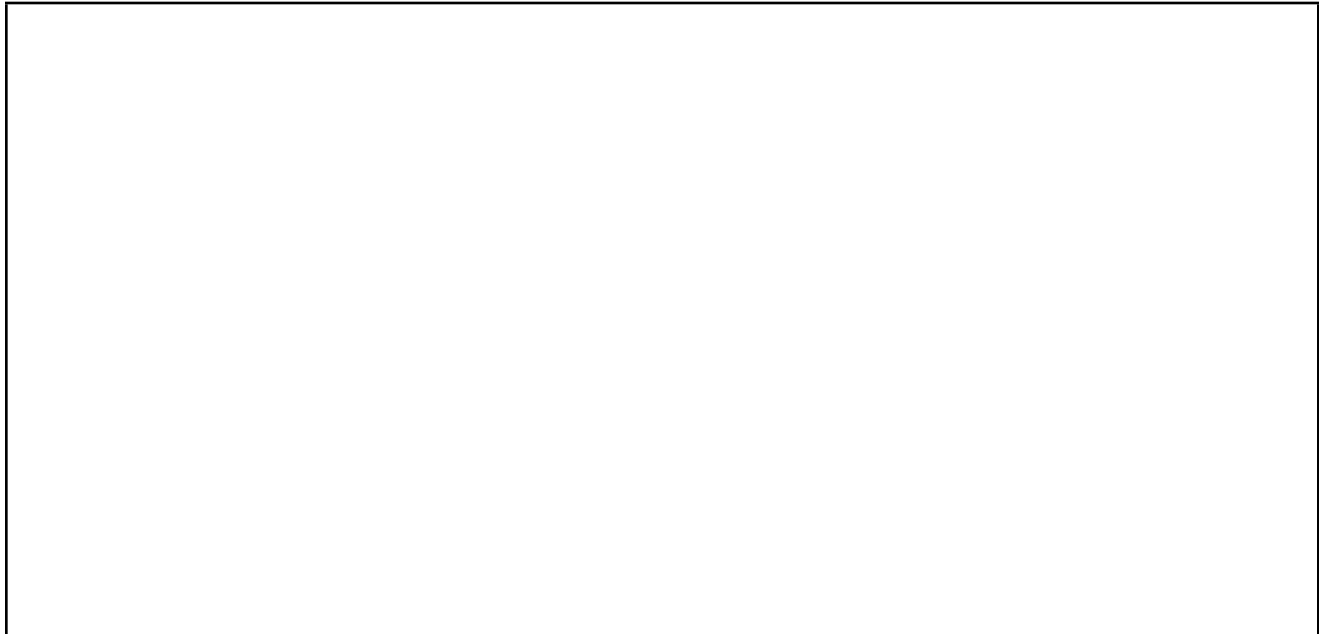

Item	Part Number	Description
1	—	Throttle Valve
2	—	Vacuum Port
3	9D475	EGR Valve
4	9F452	EGR Backpressure Transducer Valve
5	—	EVAP Canister
6	—	EGR/EVAP Control Solenoid
7	—	Vent

Exhaust Gas Recirculation System

EGR/EVAP Control Solenoid (Federal Emissions)

The exhaust gas recirculation/evaporative emission (EGR/EVAP) control solenoid (Figure 4) is controlled by the powertrain control module (PCM). The EGR/EVAP control solenoid controls vacuum to both the exhaust gas recirculation (EGR) valve and to the evaporative (EVAP) emission canister. When the EGR/EVAP control solenoid is off (ground signal OFF from the PCM) vacuum is supplied to both the EGR valve and to the EVAP canister. When the EGR/EVAP control solenoid is on (ground supplied by PCM), vacuum is turned off keeping the EGR valve closed and no vacuum to the EVAP canister. (On vehicles with California emissions there are separate solenoids for the EGR and the EVAP systems.) The PCM will command the EGR/EVAP control solenoid on at:

- Engine starting condition
- Low engine coolant temperature condition
- Excessively high engine coolant temperature condition
- Engine idling condition
- High engine speed condition
- Mass air flow sensor failure

Figure 4: Exhaust Gas Recirculation/Evaporative Emission (EGR/EVAP) Control Solenoid



Exhaust Gas Recirculation (EGR) Temperature Sensor

The exhaust gas recirculation (EGR) temperature sensor (Figure 5) is a thermistor type sensor that monitors the temperature of the exhaust in the EGR passageway. As the EGR flow increases, the temperature increases. This process creates a change in the resistance of the sensor, which decreases as the temperature increases. The signal is sent to the powertrain control module (PCM) to indicate that the EGR system is working properly. If the EGR temperature sensor does not change resistance as the PCM expects on two consecutive trips, the malfunction indicator lamp (MIL) will be illuminated and a diagnostic trouble code (DTC) will be stored.

Exhaust Gas Recirculation System

Figure 5: EGR Temperature Sensor

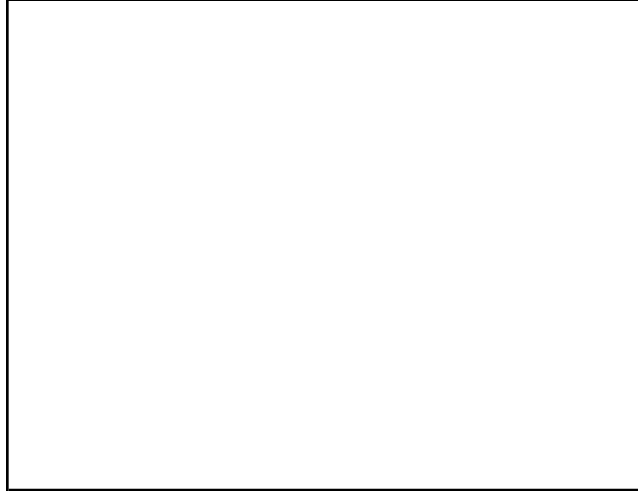

Exhaust Gas Recirculation (EGR) Valve

The exhaust gas recirculation (EGR) valve (Figure 6) recirculates portions of the exhaust gas back into the intake manifold to reduce the amount of the NO_x released during combustion and to reduce combustion temperature. The amount of exhaust gases that are released into the engine is proportional to the load on the engine.

Figure 6: EGR Valve



Evaporative Emission System

Evaporative Emission System

Evaporative Emission (EVAP) System (Federal Emissions)

The evaporative emission (EVAP) system (Figure 1) is used to absorb fuel vapors from the fuel tank. In a hot soak condition, fuel vapor pressure increases in the fuel tank. In order to reduce hydrocarbon emission into the atmosphere, fuel vapors are passed through a rollover/vent valve and into an evaporative emission (EVAP) canister. These fuel vapors are stored in the EVAP canister until they can be consumed in the engine. Under average driving conditions, the powertrain control module (PCM) will purge the EVAP canister. This purging is controlled by the exhaust gas recirculation/evaporative emission (EGR/EVAP) control solenoid. The EGR/EVAP control solenoid normally allows vapors to flow into the engine intake manifold to be burned unless the EGR/EVAP control solenoid is on (ground supplied by the PCM). The PCM allows purging of the EVAP system except under:

- Engine starting condition
- Low engine coolant temperature condition
- Excessively high engine coolant temperature condition
- Engine idling condition
- High engine speed condition
- Mass air flow sensor failure

Evaporative Emission System

Figure 1: Evaporative Emission (EVAP) System Diagram (Federal Emissions)



Item	Part Number	Description
1	—	EGR/EVAP Control Solenoid
2	—	Throttle Valve
3	—	Air Cleaner Housing
4	—	Mass Air Flow Sensor
5	—	EVAP Canister Purge Valve

(Continued)

Evaporative Emission System

Item	Part Number	Description
6	9D653	EVAP Canister
7	9030	Fuel Filler Cap
8	9002	Fuel Tank
9	9B593	Rollover/Vent Valve
10	9E325	Fuel Vapor Line
11	—	Intake Manifold

EGR/EVAP Control Solenoid (Federal Emissions)

The exhaust gas recirculation/evaporative emission (EGR/EVAP) control solenoid (Figure 2) is controlled by the powertrain control module (PCM). The EGR/EVAP control solenoid controls vacuum to both the exhaust gas recirculation (EGR) valve and to the evaporative (EVAP) emission canister. When the EGR/EVAP control solenoid is off (open signal from the PCM), vacuum is supplied to the EVAP canister and purging of the vapors in the EVAP canister is allowed. When the EGR/EVAP control solenoid is on (ground supplied by PCM), vacuum is vented to the atmosphere prohibiting purging of the EVAP system. The PCM will command the EGR/EVAP control solenoid on at:

- Engine starting condition
- Low engine coolant temperature condition
- Excessively high engine coolant temperature condition
- Engine idling condition
- High engine speed condition
- Mass air flow sensor failure

Figure 2: EGR/EVAP (EGR/EVAP) Control Solenoid



Evaporative Emission System

Evaporative Emission (EVAP) Canister (Federal Emissions)

The evaporative emission (EVAP) canister (Figure 3) is a storage device for fuel vapors that are emitted by the fuel tank in hot soak conditions. When the vehicle is at normal operating conditions, the vapors are purged from the EVAP canister. The EVAP canister is controlled by the exhaust gas recirculation/evaporative emission (EGR/EVAP) control solenoid. This solenoid sends vacuum to the EVAP canister purge valve (part of the EVAP canister) which allows the passage of the fuel vapors into the intake manifold where they are mixed with air and burned in the engine. By storing the fuel vapors and purging them into the engine at a later time, hydrocarbon emissions are reduced, and fuel efficiency is increased.

Figure 3: Evaporative Emission (EVAP) Canister

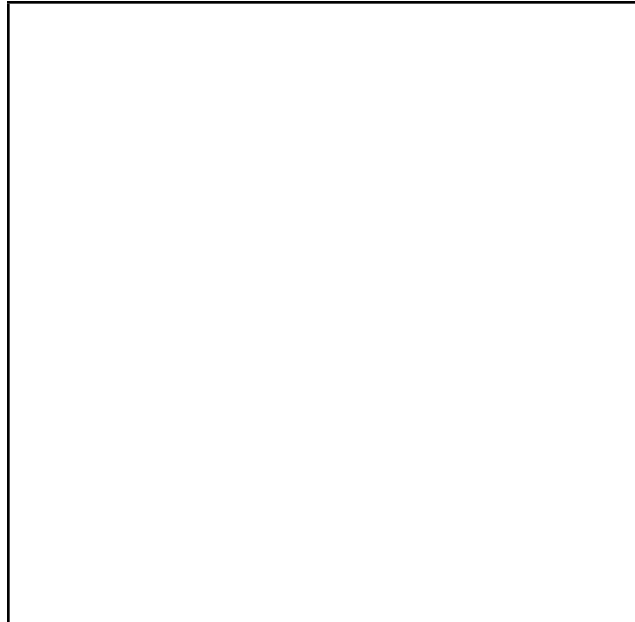

Item	Part Number	Description
1	—	Main Purge Port
2	—	EVAP Canister Purge Valve
3	—	Vent
4	9D653	EVAP Canister
5	—	Inlet From Fuel Tank
6	—	Constant Purge Port

Evaporative Emission System

Rollover/Vent Valve (Federal Emissions)

The rollover/vent valve (Figure 4) controls pressure between the fuel tank and the evaporative emission (EVAP) canister. The rollover/vent valve will allow pressure to go either way, depending on the pressure applied to the valve. When the fuel in the tank is hot, pressure increases. The rollover/vent valve releases the fuel vapors into the EVAP canister to reduce the pressure in the fuel tank. If a rollover situation occurs, the rollover/vent valve closes and will not permit fuel to escape from the fuel tank.

Figure 4: Rollover/Vent Valve

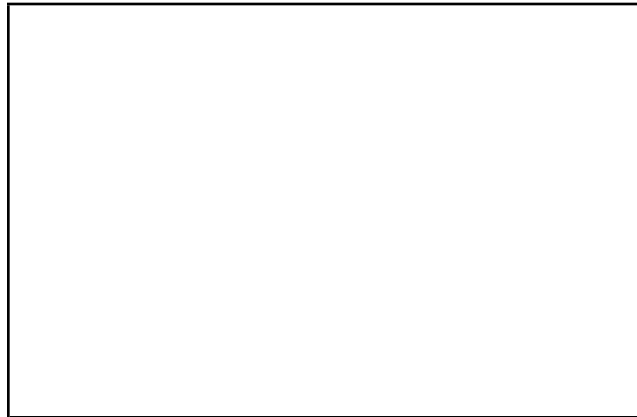

Evaporative Emission (EVAP) System (California Emissions)

The evaporative emission (EVAP) system (Figure 5) is used to absorb fuel vapors from the fuel tank. In a hot soak condition, fuel vapor pressures inside the fuel tank increase. In order to prevent the release of hydrocarbon emissions into the atmosphere, the fuel vapors are allowed to pass through a one-way check valve into the EVAP canister. These vapors are stored in the canister until they can be drawn into the intake manifold and consumed during normal engine operation. This purging is controlled by the EVAP canister purge solenoid which is normally closed until energized by the PCM. Once the PCM activates the EVAP canister purge solenoid, vacuum is directed to the EVAP canister purge control valve which allows fuel vapors to be pulled out of the canister and up to the EVAP canister volume control valve. The EVAP canister volume control valve regulates the amount of fuel vapors allowed to pass into the intake manifold. The California Emissions EVAP system also includes an EVAP test port (located under the hood) that allows leak testing of the EVAP system. During PCM self-test the EVAP system pressure is released by the EVAP vent control valve and the operation of the EVAP canister pressure sensor is tested. The PCM allows purging of the EVAP canister except under these conditions:

- Low engine coolant temperature
- Engine idling condition
- Engine starting condition
- Wide open throttle condition

Evaporative Emission System

Figure 5: Evaporative Emission (EVAP) System (California)



Evaporative Emissions (EVAP) Canister Vent Control Valve (California Emissions)

The evaporative canister (EVAP) vent control valve (Figure 6) is located on the EVAP canister. The powertrain control module (PCM) energizes the solenoid when it is necessary to close the canister vent. The EVAP canister vent valve is used only for diagnosis of the EVAP system and usually remains open. When this vent is closed under normal purge conditions the EVAP system is depressurized and allows EVAP system leak diagnosis.

Figure 6: EVAP Canister Vent Control Valve



Evaporative Emission System

EVAP Canister Pressure Sensor (California Emissions)

The EVAP canister pressure sensor (Figure 7) is an input to the powertrain control module (PCM) and is used only for on-board diagnosis of the EVAP emission system. The sensor is located in the purge line of the EVAP canister and senses changes in pressure in the EVAP canister purge line.

Figure 7: EVAP Canister Pressure Sensor

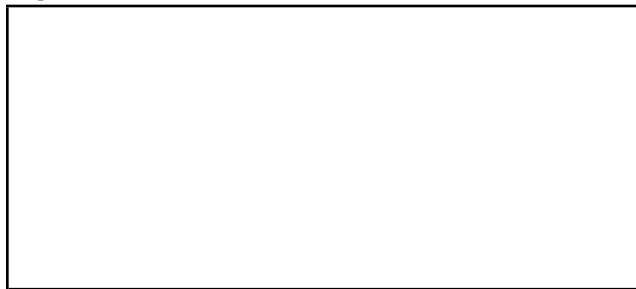

Evaporative Emission (EVAP) System Test Port (California Emissions)

The test port (Figure 8) is located under the hood near the cowl and is used to perform leak testing on the EVAP canister system.

Figure 8: EVAP System Test Port



EVAP Canister Purge Solenoid (California Emissions)

The evaporative emission (EVAP) canister purge solenoid (Figure 9) is controlled by the powertrain control module (PCM). The EVAP canister purge solenoid controls vacuum to the EVAP canister purge valve. When the EVAP purge solenoid is on (ground supplied by the PCM), vacuum is supplied to the EVAP canister purge valve and purging of vapors in the EVAP canister is allowed. When the EVAP purge solenoid is off (open signal from the PCM), the solenoid is released to prevent purging of the fuel vapors from the EVAP system.

Evaporative Emission System

Figure 9: EVAP Canister Purge Solenoid



Evaporative Emission (EVAP) Canister (California Emissions)

The evaporative emission (EVAP) canister (Figure 10) is a storage device for fuel vapors that are emitted by the fuel tank in hot soak conditions. When the vehicle is at normal operating conditions, the vapors are purged from the canister. The EVAP canister is controlled by the evaporative emission (EVAP) purge solenoid. This solenoid sends vacuum to the EVAP canister purge valve which allows the passage of the fuel vapors through the EVAP canister purge volume control valve into the intake manifold where they are mixed with air and burned in the engine. By storing the fuel vapors and purging them into the engine at a later time, hydrocarbon emissions are reduced, and fuel efficiency is increased.

Figure 10: EVAP Emissions Canister



Vacuum Cut Valve (California Emissions)

The vacuum cut valve (Figure 11) is a one-way check valve which allows fuel vapors to enter the EVAP purge line, but prevents intake manifold vacuum from being applied to the fuel tank.

Evaporative Emission System

Figure 11: Vacuum Cut Valve

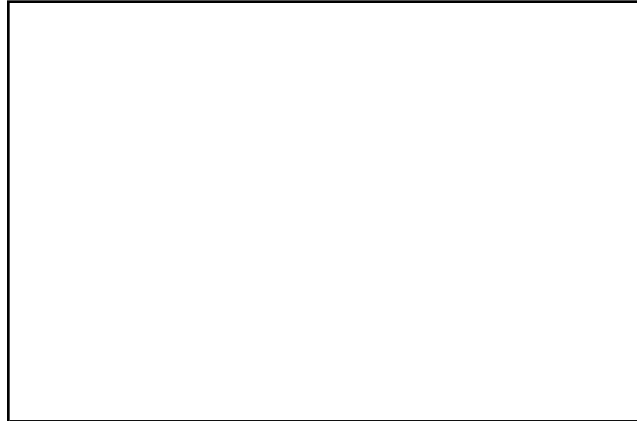

Vacuum Cut Bypass Solenoid (California Emissions)

The vacuum cut bypass solenoid (Figure 12) is installed in parallel with the vacuum cut valve on the EVAP purge line between the EVAP canister and the fuel tank. The vacuum cut bypass solenoid generally remains closed. The vacuum cut bypass solenoid is open when on (ground supplied by the PCM). When open, the vacuum cut valve is bypassed to apply intake manifold vacuum to the fuel tank. The vacuum cut bypass solenoid is used only for EVAP system diagnostics.

Figure 12: Vacuum Cut Bypass Valve



EVAP Canister Purge Valve (California Emissions)

The EVAP canister purge valve (Figure 13) is installed in the EVAP purge line between the EVAP canister and the EVAP canister purge volume control valve. When vacuum is applied to the EVAP canister purge valve it allows the passage of fuel vapors to the EVAP canister purge volume control valve.

Evaporative Emission System

Figure 13: EVAP Canister Purge Valve

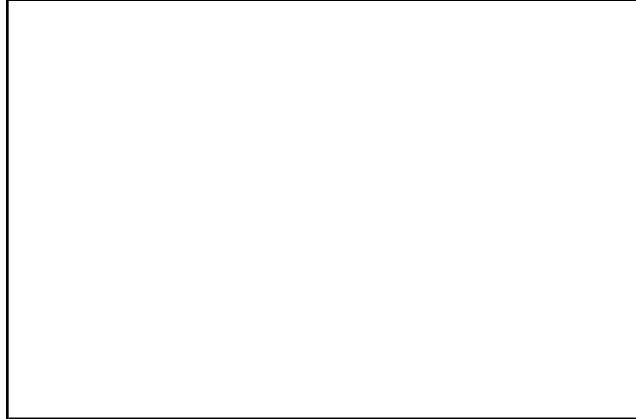

Water Separator (California Emissions)

The water separator (Figure 14) is attached to the EVAP canister vent control valve inlet. When the EVAP canister vent control valve is open, air is drawn into the EVAP canister through the water separator. The water separator draws water vapor from the incoming air and then vents it back to the atmosphere.

Figure 14: Water Separator



MAP/BARO Sensor (California Only)

The MAP/BARO sensor (Figure 15) is an input to the powertrain control module (PCM). The sensor is used in conjunction with a MAP/BARO solenoid that either supplies manifold vacuum (MAP function) to the MAP/BARO sensor or opens the sensor to atmospheric pressure (BARO function). The PCM uses the MAP/BARO data to control the EVAP emissions system.

Evaporative Emission System

Figure 15: MAP/BARO Sensor

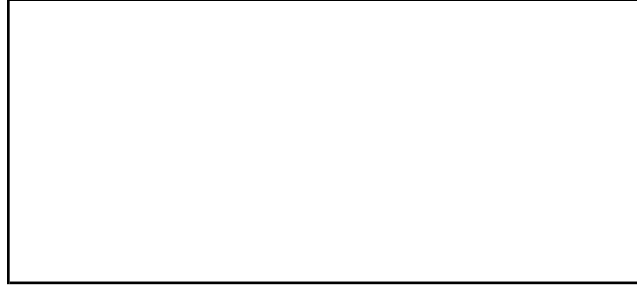

MAP/BARO Solenoid (California Only)

The MAP/BARO solenoid (Figure 16) switches air flow passage between manifold vacuum and atmospheric pressure upon demand from the PCM. When voltage is supplied from the PCM, the MAP/BARO solenoid turns "ON". When "ON" the MAP/BARO sensor monitors barometric pressure (BARO); when the MAP/BARO solenoid is "OFF" manifold vacuum is monitored (MAP).

Figure 16: MAP/BARO Solenoid

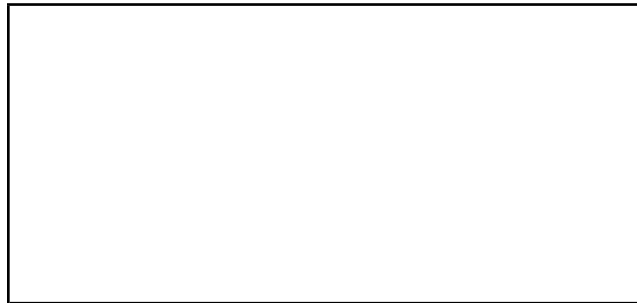

Intake Air and Throttle Body System

Intake Air and Throttle Body System

Intake Air System

The intake air system delivers filtered and controlled air flow to the engine. Three groups of components make up the system: air handling, sensors, and control devices.

Intake Air System Air Handling Components

Intake air system components include:

- Air inlet duct
- Air cleaner
- Throttle body
- Intake manifold
- Resonance chambers

The resonance chamber suppresses air inlet noise caused by air flow pulsations. The throttle body contains the throttle valve and throttle position (TP) sensor.

Intake air system air handling components include the inlet air duct, air cleaner, throttle body (TB), intake manifold, and three resonance chambers. The resonance chambers suppress air inlet noise caused by air flow pulsations. The TB contains the throttle valve and throttle position (TP) sensor.

Intake Air System Sensors

Intake air system sensors include a heated resistor-type mass air flow (MAF) sensor and throttle position (TP) sensor; both supply data to the powertrain control module (PCM). The PCM also monitors engine speed.

Idle Air Control (IAC) Valve 1

The idle air control (IAC) valve 1 (Figure 1) compensates for idle speed change caused by the operation of the air conditioner compressor. The IAC valve 1 is controlled by the PCM, and is energized when the air conditioner clutch is energized.

Intake Air and Throttle Body System

Figure 1: Idle Air Control (IAC) Valve 1

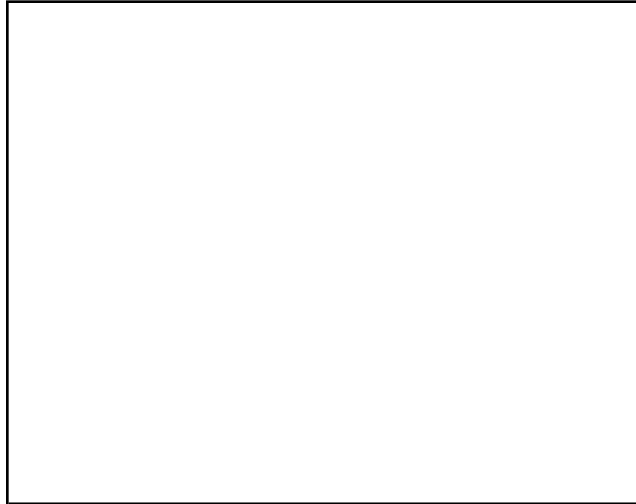

Idle (IDL) Switch

The idle (IDL) switch (Figure 2) detects idle position when the throttle plate is closed and sends a signal to the powertrain control module (PCM). This signal is sent by the PCM to the transmission control module (TCM) for transmission torque converter clutch control.

- Fuel injection
- Ignition timing
- Fuel pump
- Idle speed

Intake Air and Throttle Body System

Figure 2: Idle Switch

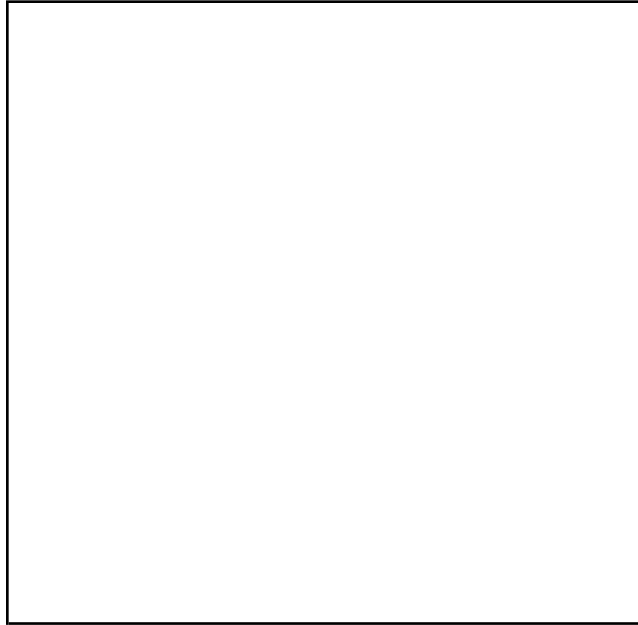

Idle Air Control (IAC) Valve 2

The idle air control (IAC) valve 2 (Figure 3) adjusts the amount of air allowed into the engine at idle condition and during rapid engine deceleration. This adjustment is done by means of an adjustable duty cycle output by the powertrain control module (PCM). The PCM increases the duty cycle based on different inputs such as RPM, load and others.

Figure 3: Idle Air Control (IAC) Valve 2

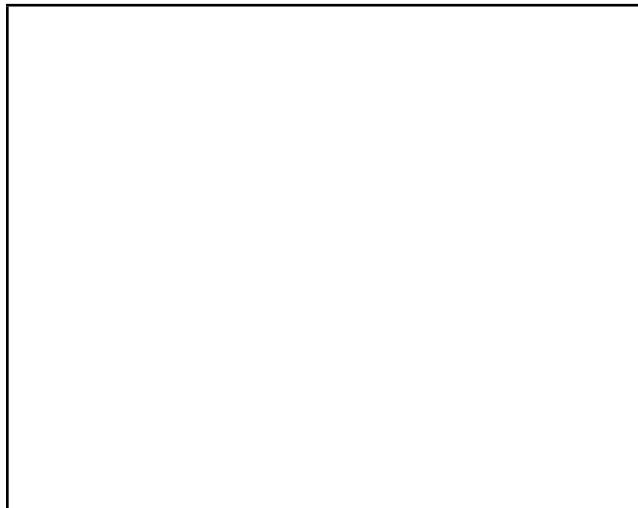

Intake Air and Throttle Body System

Mass Air Flow (MAF) Sensor

The mass air flow (MAF) sensor (Figure 4) is a heated resistor type that indicates to the powertrain control module (PCM) the amount of air being allowed into the engine. The MAF sensor works by trying to keep a resistor at a constant high temperature. The temperature of the hot resistor is referenced with the temperature of a resistor that is held at ambient temperature. As air passes by the heated resistor, the temperature drops and the PCM compensates by allowing more voltage to the MAF. The more air that flows past the heated resistor, the more the temperature will change and cause an increase in required voltage from the PCM. This change in voltage indicates to the PCM that there is more air flowing through the MAF so the PCM can adjust fuel flow, ignition timing, and other outputs.

Figure 4: Mass Air Flow (MAF) Sensor



Throttle Body

The throttle body (Figure 5) controls the amount of air that flows into the engine through a single butterfly valve. The single butterfly valve opening is determined by the accelerator pedal. The throttle body is cast with an air bypass channel and houses several emission-related components for the powertrain control module (PCM).

Intake Air and Throttle Body System

Figure 5: Throttle Body Assembly

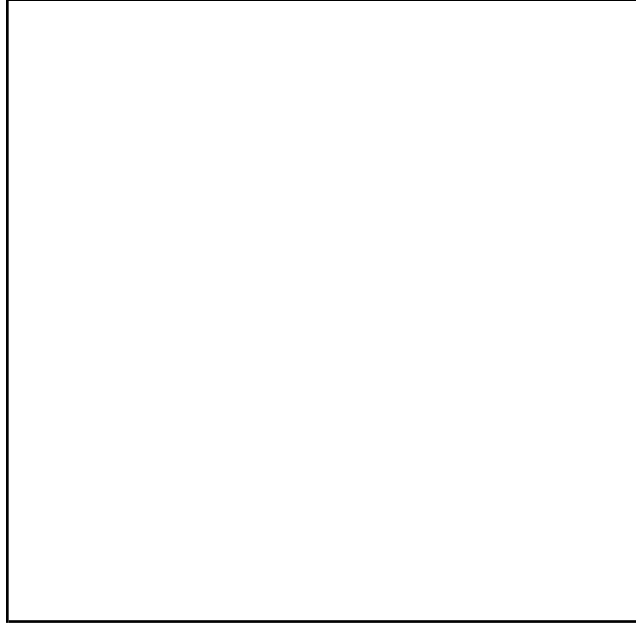

Throttle Position (TP) Sensor

The throttle position (TP) sensor (Figure 6) responds to the accelerator pedal movement. The TP sensor is a potentiometer that transforms the throttle plate opening angle into output voltage and sends the voltage signal to the powertrain control module (PCM). In addition, the sensor detects the opening and closing speed of the throttle plate and sends the voltage signal to the PCM. Also, the TP sensor is used to determine the air intake when the mass air flow (MAF) sensor fails. This mode of operation is called fail safe.

The TP sensor integrates the idle (IDL) switch within the housing. The IDL switch detects when the throttle plate is closed and an idle condition occurs. The PCM is supplied with this input signal.

Intake Air and Throttle Body System

Figure 6: Throttle Position (TP) Sensor



Positive Crankcase Ventilation System

Positive Crankcase Ventilation

Positive Crankcase Ventilation (PCV) System

The positive crankcase ventilation (PCV) system (Figure 1) vents harmful blow-by fumes from the engine crankcase into the engine air intake for burning with the fuel and air mixture. The PCV valve limits crankcase blow-by gas to the fresh air intake to suit the engine demand and serves to prevent combustion from backfiring into the crankcase. Thus, the benefits from the PCV system include the ability to:

- Maximize the oil cleanliness by venting moisture and corrosion from the crankcase.
- Protect against excessive crankcase pressure.
- Automatically regulate the ventilation system air flow to the engine air intake as required by engine operating conditions.

Figure 1: Positive Crankcase Ventilation (PCV) System

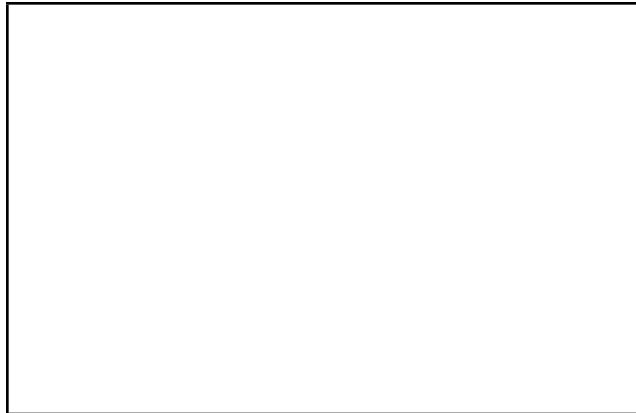

Positive Crankcase Ventilation (PCV) Valve

The positive crankcase ventilation (PCV) valve (Figure 2) is provided to regulate crankcase blow-by gas to the intake manifold. Normally, the capacity of the valve is sufficient to handle all blow-by and a small amount of ventilating air.

Positive Crankcase Ventilation

Figure 2: Positive Crankcase Ventilation (PCV) Valve



Catalyst and Exhaust System

Catalyst and Exhaust System

Overview

The catalytic converter and exhaust system work together to control the release of harmful engine exhaust emissions into the atmosphere. The engine exhaust gas consists mainly of nitrogen, carbon dioxide and water vapor. However, it also contains carbon monoxide, oxides of nitrogen, hydrogen, and various unburned hydrocarbons. Carbon monoxide, oxides of nitrogen, and hydrocarbons are major air pollutants, and emission into the atmosphere must be controlled.

The exhaust system consists of an exhaust manifold, warm up three way catalytic converter (WU-TWC), upstream heated oxygen sensor (HO2S), (located just in front of the WU-TWC), three way catalytic converter (TWC), downstream HO2S (located behind the TWC), a muffler and an exhaust tailpipe.

Heated Oxygen Sensors

The '98 Villager is equipped with both upstream and downstream heated oxygen sensors (HO2S) (Figure 1), as OBD II legislation mandates. The upstream heated oxygen sensor (HO2S11) is used to control engine fuel flow. The sensor detects the concentration of oxygen in the exhaust gas and sends a signal to the powertrain control module (PCM). In a rich condition, the HO2S will output a voltage of 0.6 volts or greater, and in a lean condition a voltage of 0.4 volts or less will be output.

The downstream heated oxygen sensor (HO2S12) is used primarily for monitoring the efficiency of the catalytic converter system. The HO2S12 works in a similar way to the HO2S11 but only indicates to the PCM that the catalyst is functioning properly. In the event that the HO2S11 fails, fuel control will be switched over to the HO2S12 and the malfunction indicator lamp (MIL) will be illuminated. This allows the vehicle to operate with fewer emissions, even with a sensor failure.

Figure 1: Typical Heated Oxygen Sensor (HO2S)



Three Way Catalytic Converter (TWC) System

The engine exhaust consists mainly of nitrogen (N_2); however, it also contains carbon monoxide (CO), carbon dioxide (CO_2), water vapor (H_2O), oxygen (O_2), nitrogen oxides (NOx), and hydrogen (H_2) as well as various unburned hydrocarbons (HC). Three of these exhaust components - CO, NOx, and HC - are major air pollutants, so their emission to the atmosphere must be controlled.

Catalyst and Exhaust System

The three way catalytic converter (TWC) (Figure 2), mounted in the engine exhaust system, works as a gas reactor to convert and reduce the pollutant levels to within legally prescribed limits.

The TWC reduces the air pollutants HC, CO, and NOx. The TWC removes these pollutants from the exhaust gases by means of a chemical reaction. The remaining gases are transferred to the muffler.

Figure 2: Three Way Catalytic Converter (TWC)

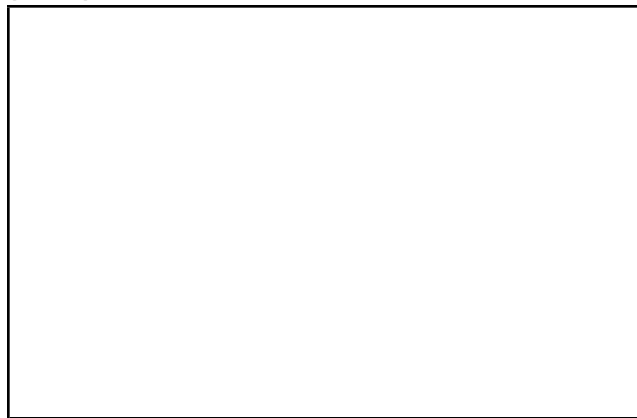

The catalyst metals are thinly coated onto and supported by a honeycomb shaped high temperature ceramic, mounted inside the converter shell. The result is a highly effective converter design having minimum restriction to exhaust gas flow and good durability.

Warm Up Three Way Catalytic Converter

The warm up three way catalytic converter (WU-TWC) (Figure 3) is designed to reduce HC, CO, and NOx during warm up conditions.

The WU-TWC is mounted ahead of the TWC, causing it to warm up faster upon vehicle start up. This results in less air pollutants escaping during warm up.

Figure 3: Warm Up Three Way Catalytic Converter (WU-TWC)



3.0L System Schematic

3.0L System Schematic

Mechanical Emission Related Systems

Schematic Diagram (Federal Emissions)



Component Identification

Item	Base Part Number	Description	System
1	9F491	Idle Air Control (IAC) Valve 2	Bypass Air Control
2	9B981	EGR/EVAP Control Solenoid (Federal Emissions)	EGR, EVAP and PCM
3	8K621	Engine Cooling Fans	Cooling System
4	12A650	Powertrain Control Module (PCM)	PCM
5	12B565	Transaxle Control Module (TCM)	TCM
6	13466	Malfunction Indicator Light (MIL)	PCM
7	9C968	Fuel Pressure Regulator	Fuel Delivery
8	9F491	Fast Idle Cam	Inlet Air Control

(Continued)

3.0L System Schematic

Item	Base Part Number	Description	System
9	9989	Throttle Position (TP) and Idle (IDL) Switch	Inlet Air Control and PCM
10	18549	Air Conditioning Switch	PCM
11	3N824	Power Steering Pressure Switch	PCM and Power Steering
12	—	Battery	Charging System
13	9E731	Vehicle Speed Sensor (VSS)	PCM and Speedometer
14	9350	Fuel Pump	Fuel Delivery
15	—	Fuel Tank	Fuel Delivery
16	—	Intake Air Temperature (IAT) Sensor	PCM
17	9600	Air Cleaner	Inlet Air Control
18	12B579	Mass Air Flow (MAF) Sensor	Inlet Air Control and PCM
19	9D653	Evaporative Emission (EVAP) Canister	Evaporative Emission
20	9D653	Evaporative Emission (EVAP) Canister Purge Valve	Evaporative Emission
21	12A648	Engine Coolant Temperature (ECT) Sensor	PCM
22	12A699	Knock Sensor (KS)	PCM
23	—	Warm Up Three Way Catalytic Converter (WU-TWC)	Catalyst and Exhaust
24	9F472	Upstream Heated Oxygen Sensor (HO2S11)	Catalyst and Exhaust and PCM
25	5E212	Three Way Catalytic Converter (TWC)	Catalyst and Exhaust
26	9F472	Downstream Heated Oxygen Sensor (HO2S12)	Catalyst and Exhaust and PCM
27	5230	Muffler	Catalyst and Exhaust
28	7A247	Transmission Range Switch (TRS)	Transaxle and PCM
29	—	Crankshaft Position (CKP) Sensor	PCM
30	9C315	Camshaft Position (CMP) Sensor	PCM
31	12405	Spark Plug 6	Ignition System
32	9F593	Fuel Injector (INJ) 6	Fuel Delivery
33	—	EGR Temperature Sensor	Exhaust Gas Recirculation and PCM
34	6A666	PCV Valve	Positive Crankcase Ventilation
35	—	Idle Air Control (IAC) Valve 1	Inlet Air Control and PCM
36	12029	Ignition Coil	Ignition System
37	—	Power Transistor	Ignition System
38	9F489	EGR Valve	Exhaust Gas Recirculation
39	11572	Ignition Switch	Ignition System
40	—	EGR Backpressure Transducer	Exhaust Gas Recirculation

SECTION 1B

Description and Operation

Contents

VEHICLE EMISSION CONTROL INFORMATION

Vehicle Emission Control Information..... 1B-2

Engine/Vehicle Applications and VIN Location..... 1B-13

ON BOARD DIAGNOSTICS II SYSTEM

On Board Diagnostics II System..... 1B-15

Trips and Drive Cycles..... 1B-21

Malfunction Indicator Lamp (MIL) 1B-23

IGNITION SYSTEM

Ignition System..... 1B-25

FUEL SYSTEM

Fuel System 1B-29

EXHAUST GAS RECIRCULATION SYSTEM

Exhaust Gas Recirculation System 1B-36

EVAPORATIVE EMISSION SYSTEM

Evaporative Emission System 1B-43

INTAKE AIR AND THROTTLE BODY SYSTEM

Intake Air and Throttle Body System..... 1B-55

SECTION 1B

Description and Operation

Contents (continued)

POSITIVE CRANKCASE VENTILATION SYSTEM

Positive Crankcase Ventilation 1B-62

CATALYST AND EXHAUST SYSTEM

Catalyst and Exhaust System..... 1B-65

3.0L SYSTEM SCHEMATIC

3.0L System Schematic 1B-68